



Fall Protection



3M™ DBI-SALA®
Fall Protection Full Line
Catalogue | 2021/2022
Harnessing safety through science.

The ABC's of fall protection.

A typical Personal Fall Arrest System (PFAS) incorporates three components, often described as the ABC's of fall protection. The anchorage/anchorage connector, body support and connecting device—when used together—form a complete system for maximum worker protection. But don't forget the other important components of a comprehensive fall protection program: descent and rescue, education and fall protection for tools.

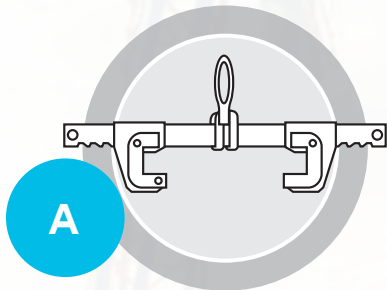

Anchorage

are a secure point of attachment. Anchorage connectors vary by industry, job, type of installation and structure. They must be able to support the intended loads and provide a sufficient factor of safety for fall arrest.

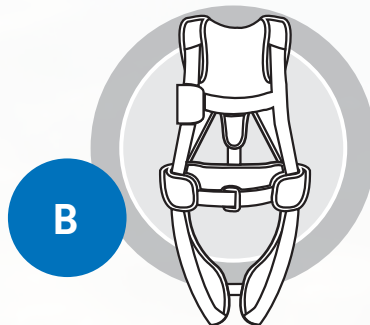

Body support

harnesses distribute fall forces over the upper thighs, pelvis, chest and shoulders. They help provide a connection point on the worker for the personal fall arrest system.

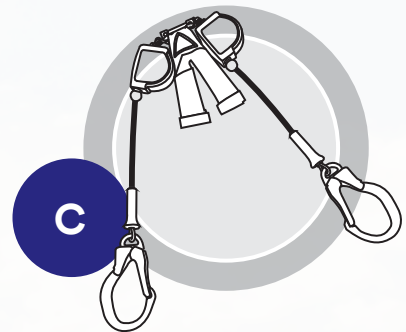

Connectors

such as self-retracting lifelines or shock-absorbing lanyards connect a worker's harness to the anchorage.

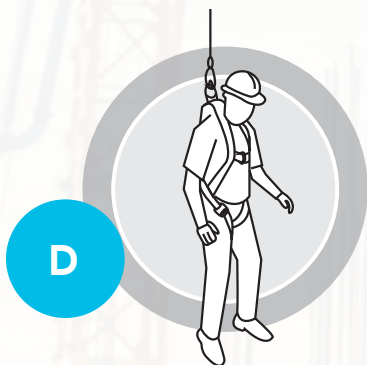

Descent and rescue

devices are used to raise or lower a fallen injured worker to safety or retrieve him from a confined space.

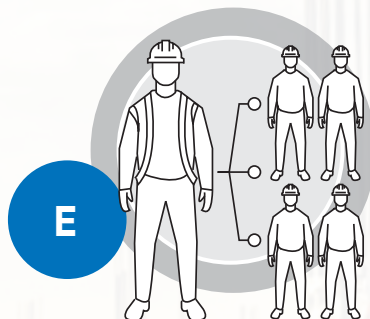

Education

is essential. We offer a variety of training and consultative services to fit your needs.

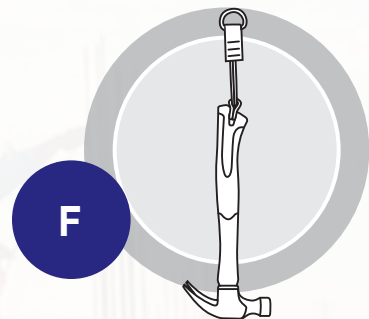

Fall protection for tools

helps make work environments safer and more productive by reducing dropped object incidents.



Table of Contents

Harnesses	9-24
Energy-Absorbing Lanyards	25-38
Self-Retracting Lifelines	39-46
Anchorage Connectors	47-60
Confined Space Rescue	61-78
Flexiguard™ Solutions	79-90
Horizontal Systems	91-98
Vertical Systems	99-106
Rescue and Decent	107-116
Fall Protection for Tools	117-136
Engineered Systems	137-138



Fall Protection

Trade In and Trade Up

To new 3M fall protection equipment and enjoy the added confidence when working at heights.

Begin your trade in and receive a purchase rebate* at [3M.ca/FallProTradeUp](https://www.3M.ca/FallProTradeUp)

*Some restrictions apply. 3M reserves the right to discontinue or change this program at any time, without warning. 3M and its agents are not responsible for incomplete applications. 3M reserves the right to deny and/or disregard any request deemed to be false or fraudulent. This Trade in, Trade up Program may not be combined with other promotions. 3M's use of information submitted in your Trade in, Trade up Program registration will be treated in accordance with our Privacy Policy. For more information or to learn the status of your Trade in, Trade up Program registration form, go to www.3M.ca/FallProTradeUp.



Elevated education. Applied to working at heights.

3M Safety Training

We are an industry leader in fall protection and high angle rescue training and a proud member of the 3M team.

We take pride in the creation and delivery of our services across geographies training workers at height. Whether it's delivering end-user training or a certified instructor program, we put all of our effort, resources and expertise into every service we provide.

With a wide variety of course offerings, we can assist you with programs in fall protection and high angle rescue or we can apply our specific knowledge to deliver a tailored program to your organization.

Our programs have the support, recognition, endorsement and accreditation from a variety of companies, groups, associations and governing bodies. Contact our office to learn more.

At-height work is at the core of what we do. Regardless of your industry and company size, our expertise can help enhance safety practices in organizations like yours, including:

- manufacturing
- construction (residential, commercial, industrial)
- transportation (including railroads and airlines)
- mining
- oil and gas and energy
- power generation and distribution
- telecom
- theatrical rigging
- government and regulatory

Call 1-888-FALLPRO or visit SafetyTraining.3M.com to learn more.



Open enrollment and on-site courses available.

Training Centres in Mississauga and Calgary.
Meets CSA requirements.

Certified Instructor Programs

Interested in delivering training to your workers? Get the training backed and supported by the leader in fall protection training.

Teach the latest content and materials through our certified instructor program, which is continuously updated and maintained. Our leading approach takes your present training abilities and combines it with our program methodology to create a winning solution for delivering training to your workers or for your independent training group.

Our Expertise

In addition to delivering training, 3M Safety Training is a resource for many organizations. We work with and provide training to OH&S Officers in Canada and OSHA Compliance Officers in the U.S.

Take advantage of our experience and dedication to training by attending one of our programs delivered at our training location or yours. If you need added flexibility, we currently offer open enrollment courses in Calgary, Edmonton, Mississauga, and select other cities in Canada. Contact us to discuss your needs and let us make a plan that fits your group.

Programs We Offer

General Fall Protection	Course #
Authorized Person Essentials	6408
Authorized Person Comprehensive	6418
Competent Person	6424
Working at Heights	6212

Specialized Fall Protection	
Equipment Inspection	6222
Wood Pole Climbing	6231
Tower Climbing	6233
Railroad Bridge Climbing and Inspection	6235
Temporary HLL Installation	6203
Dropped Objects	6205

General High Angle Rescue	
Technical Rescue Level I	6603
Technical Rescue Level II	6613

Specialized High Angle Rescue	
Railroad Bridge	6631
Tower	6641
Wind Energy	6643
Theatre	6628
Pole Top	6653

Confined Space	
Entrant and Attendant	6235
Entry Supervisor and Program Manager	6482
Rescue	6493



Connected Safety



Enhance compliance. Save time. Be proactive.

With 3M™ Inspection and Asset Management Software, now with a fall protection specific package, you're not just streamlining your safety and asset management system—you're giving yourself access to real-time data that can help you enhance worker protection.

To learn more or visit
3M.ca/ConnectedSafety to request a demo.

2020/2021 New Product Launches

3M™ DBI-SALA® Nano-Lok™ Connected Order Picker Self Retracting Lifeline System

Innovative fall protection system that senses a worker's presence on an order picking vehicle, verifies their tie-off status, and communicates visual and audible alerts in real time to promote situational awareness and safe behaviour.

See page 40



3M™ DBI-SALA® Smart Lock Self-Retracting Lifeline: Arc Flash

20 ft (6 m) of 7/32" (5.5 mm) Technora® polyester rope lifeline with Kevlar® sheath.

See page 46.



3M™ DBI-SALA® Nano-Lok™ Extended Length Self-Retracting Lifeline

We're advancing the versatility of 3M™ DBI-SALA® Nano-Lok™ SRLs. Available in 9 ft (2.7 m), 11 ft (3.3 m), 15 ft (4.5 m), and now 20 ft (6 m) lengths, the family of Nano-Lok™ SRLs combines fall protection with ease-of-use and comfort for even more applications.

See page 41.



3M™ DBI-SALA® Nano-Lok™ Personal Self Retracting Lifeline

Experience a more compact design with a tougher, longer-lasting cover. It's easier and faster to connect* (*compared to previous generation) with the ability to arrest a fall from an overhead anchorage at 4 ft (1.2 m).

See page 43.



3M™ DBI-SALA® Flexiguard™ Modular Jib System

Available in the M100 and M200 Series, this system features a simplified design that enhances worker safety in multiple applications. Increased rail-length configurations improve working coverage while a new design facilitates easier system transport.

See pages 80-82.

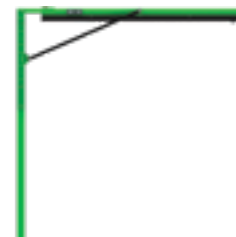

3M™ DBI-SALA® Fixed Ladder SRL Anchors

Ideal fall protection solution for step-through style fixed ladder systems.

See pages 60 and 104.





Full-Body Harnesses

Harnesses

When you're 75' (23 m) off the ground, your harness is more than just your safety connection—it's everything.

The right safety harness provides comfort and confidence, and directly affects the user's productivity, as well as gives them versatility to do what needs to be done on the job site. 3M™ DBI-SALA® Harnesses have earned a reputation as top body harnesses for maximum comfort, freedom of movement and ease-of-use.

We've launched innovations such as the spring-loaded, stand-up back D-ring, 3M™ DBI-SALA® Delta™ No-Tangle Pad, locking quick connect buckles and the Revolver™ Torso Adjuster. While many of our harnesses can be used on most jobs, we also manufacture harnesses for specific uses within different industries, like Construction, Oil and Gas, Transportation, Utilities/Telecommunications and Wind Energy.

Best of all, you can rest assured all of our industry-leading harnesses meet applicable CSA standards and regulations.



Choosing Your Harness

Look for quality in these features when selecting your harness.

Dorsal connection

The fall arrest attachment point must be located on the back, positioned between the shoulder blades. Your harness must always include a dorsal attachment point, but some may also allow you to attach SRLs without pulling up the webbing or impeding use of the D-ring, like with our EZ-Link™ Technology.

Webbing

Webbing is an important factor in the durability and safety of the harness. Ensure that the webbing is strong enough to endure rough use, exposure to sunlight and other elements without tearing or fraying. Specialty applications such as welding and electrical maintenance require the use of Nomex®/Kevlar® fibres or nylon that offers fire resistance or arc flash protection.

Adjusting points

Whether you wear a harness 4 hours a day or 14, it needs to fit right for safety and comfort. Harnesses with adjusting points on the legs, waist (belt models), chest and torso allow a better fit.

Leg straps

Depending on worker preference, leg strap fasteners may be available in different styles, including:



Tongue Buckle



Pass-Through Buckle



Quick-Connect Buckle

Pelvic support

A sub-pelvic strap provides additional support, security and comfort for the user. Properly positioned, it better distributes forces during a fall.



Book-style labels

Book-style labels put product and inspection information at the worker's fingertips. Pages may include sizing, operating instructions, inspection log, warning labels and compliance information. These labels promote quick inspection, compliance and safety.



Stitching

Double box stitching provides maximum strength and durability. It's sewn-in quality you can trust.



Padding

Cushioned shoulder, leg and hip pads keep the pressure off, providing extra worker comfort for long hours of wear. In a fall, they absorb shock and help distribute your weight. They may be built-in to avoid slipping or may be removable.

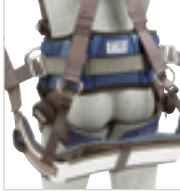

Seat slings

A removable seat sling provides job versatility and added comfort during long hours of use.

Impact indicators

Impact indicators provide immediate notice that the worker and harness have been in a fall. This feature promotes safety and proper inspection.



Lanyard keepers

A lanyard keeper provides a place to park your lanyard when not in use. It helps prevent tripping and entanglement for enhanced safety.

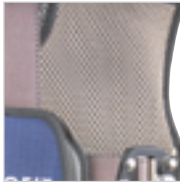

Breathable linings

Breathable linings, like those found in 3M™ DBI-SALA® ExoFit™ Harnesses, wick moisture away from your body, so you stay dry and comfortable in heat or cold.

Suspension trauma straps

Suspension trauma straps are easily deployed and hook together in seconds, allowing you to stand up while suspended in harness with one or both feet to relieve leg trauma.

3M™ DBI-SALA® Full-Body Harness Sizing Chart

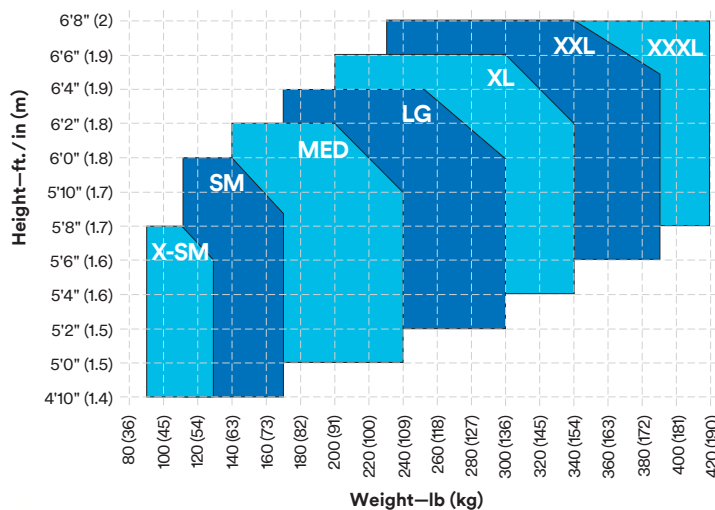

Which 3M™ DBI-SALA® Harness is right for you?

ExoFit™ STRATA™ Harness | The light-wearing full-body harness that's ideal for those who wear personal SRLs (See page 12)

ExoFit™ NEX Harness | The gold standard in comfort, function and durability (See pages 13-17)

ExoFit™ Harness | The original comfort harness (See pages 16-18)

Delta™ Harness | The workhorse of the industry: Durable, convenient and comfortable (See pages 19-21)

Types of harnesses

3M™ DBI-SALA® Harnesses are available in different types, with various features, depending on their intended use.



Multi-purpose harness

This type typically includes extra attachment points which allow work in a variety of situations. The belt and pad provide additional back lumbar support, positioning rings and tool carrying options.



Work positioning harness

These harnesses have positioning D-rings located on the hips for use with pole straps or work positioning lanyards, which allow hands-free operation. Harnesses of this kind may include integral waist belts.



Ladder climbing harness

Harnesses with a frontal attachment point, for connection to permanent ladder safety systems.



Descent control harness

These harnesses typically have frontal attachment points for use with descent control devices.



Confined entry/ retrieval harness

One attachment point located on each shoulder strap facilitates upright retrieval from confined spaces.



Suspension/ rigging harness

These harnesses typically include extra attachment points such as back, front and side D-rings, which allow use in a variety of climbing, positioning, descent and rescue applications.

Harnesses

3M™ DBI-SALA® ExoFit™ STRATA™

Construction-Style Harnesses



Description	Small	Medium	Large	XLarge
Tri-Lock Revolver™ Buckles, back and side D-rings	1112535C	1112536C	1112537C	1112537C
Duo-Lok™ Quick-Connect Buckles, back and side D-rings	1112550C	1112551C	1112552C	1112553C
Tri-Lock Revolver™ Buckles, back, front and side D-rings	1112540C	1112541C	1112542C	1112553C
Tongue buckle leg straps, back and side D-rings	1112565C	1112566C	1112567C	1112568C

Tower-Climbing Harnesses



Description	Small	Medium	Large	XLarge
Tri-Lock Revolver Buckles, aluminum front, back and side D-rings, removable seat sling with positioning D-rings	1112580C	1112581C	1112582C	1112583C
Tongue buckle leg straps, aluminum front, back and side D-rings, removable seat sling with positioning D-rings	1112585C	1112586C	1112587C	1112588C

Vest-Style Harnesses without LIFTech™ Technology



Description	Small	Medium	Large	XLarge	2X
Aluminum back D-rings, Tri-Lock Revolver™ Quick-Connect Buckles, comfort padding	1112475C	1112476C	1112477C	1112478C	1112479C
Positioning Harness. Aluminum back and side D-rings, Tri-Lock Revolver™ Quick-Connect Buckles, comfort padding.	1112480C	1112481C	1112482C	1112483C	1112484C
Climbing Harness. Aluminum back, front and side D-rings, tongue buckle leg straps, Tri-Lock Revolver™ chest strap, comfort padding	1112530C	1112531C	1112532C	1112533C	1112534C
Aluminum back, front, and side D-rings, Tri-Lock Revolver™ Quick-Connect Buckles, comfort padding	1112490C	1112491C	1112492C	1112493C	1112494C
Aluminum back and side D-rings, tongue buckle leg straps, Tri-Lock Revolver™ chest strap, comfort padding	1112520C	1112521C	1112522C	1112523C	1112524C
Aluminum back and side D-rings, Duo-Lok™ Quick-Connect Buckles, comfort padding	1112500C	1112501C	1112502C	1112503C	1112504C

3M™ DBI-SALA® ExoFit™ NEX/ExoFit™ NEX Plus

Vest-Style Full-Body Harnesses

Vest-Style Harnesses are the most universal, with multiple configurations and connection point options. They're used across a wide variety of industries.



Description	Small	Medium	Large	XLarge
Aluminum front and back D-rings, locking quick-connect buckles	1140109C	1140110C	1140111C	1140112C
Aluminum back and shoulder D-rings, locking quick-connect buckles	1113061C	1113064C	1113067C	1113070C
Aluminum back D-ring, locking quick-connect buckles	1140103C	1140104C	1140105C	1140106C
Aluminum back and side D-rings, locking quick-connect buckles	1140115C	1140116C	1140117C	1140118C
Aluminum front, back and side D-rings, locking quick-connect buckles	1140121C	1140122C	1140123C	1140124C

Crossover-Style Harnesses

A front-mounted D-ring makes the crossover-style ideal as a rescue harness and for ladder climbing applications.



Description	Small	Medium	Large	XLarge
Aluminum front and back D-rings, locking quick-connect buckles	1113091C	1113094C	1113097C	1113100C
Aluminum front, back and side D-rings, locking quick-connect buckles	1140199C	1140200C	1140201C	1140202C

3M™ DBI-SALA® ExoFit™ NEX Plus

Tower Climbing Harnesses

Tower climbing models are built to keep workers comfortable during extended hours in harness. Tool loops are ideal for carrying equipment.

Description	Small	Medium	Large	XLarge
Aluminum front, back and side D-rings, locking quick-connect buckles with sewn-in hip pad and belt, removable seat sling with positioning D-rings	1140169C	1140170C	1140171C	1140172C



A removable seat sling adds even more comfort, for those who wear them all day long.

Harnesses

3M™ DBI-SALA® ExoFit™ NEX Plus

Construction-Style Harnesses

Made for general construction work, these harnesses have excellent tool-carrying capability, sewn-in hip pad and removable body belt.



Description	Small	Medium	Large	XLarge
Aluminum back and side D-rings, locking quick-connect buckles with sewn-in hip pad, removable belt	1140157C	1140158C	1140159C	1140160C
Aluminum front, back and side D-rings, locking quick-connect buckles, sewn-in hip pad, removable belt	1140163C	1140164C	1140165C	1140166C
Aluminum back and side D-rings, tongue buckle legs, sewn-in hip pad, removable belt	1140181C	1140182C	1140183C	1140184C



Capability
Integrated EZ-Link™ SRL Adapter lets you quickly and easily connect and disconnect personal SRLs.



Comfort
Keep your back D-ring in place with the anti-slide feature stitched in to the harness webbing.



Convenience
Reposition the auto-resetting lanyard keepers along chest area of harness webbing.

3M™ DBI-SALA® ExoFit™ NEX

Global Wind Energy Harnesses

People around the world rely on our wind industry harnesses because they meet the major global compliance standards including ANSI, OSHA, CSA and CE.



Description	Small	Medium	Large	XLarge
Aluminum front, back and side D-rings, locking quick-connect buckles and sewn-in hip pad with belt and lumbar wear protection	1113215	1113216	1113217	1113218
Aluminum front, back and side D-rings, locking quick-connect buckles	1113210	1113211	1113212	1113213



Replaceable lumbar protector
The lumbar protector is easily replaced in the field when worn or damaged.



Radio holster
Conveniently holds and protects a radio, cell phone, or other items.

Mining Vest-Style Harnesses

We've designed these harnesses specifically to allow miners to conveniently carry the equipment they need, such as batteries for their escape gear and lamps, to get the job done.

Description	Small	Medium	Large	XLarge
Aluminum back D-ring, locking quick-connect buckles, integrated hip padding with belt and miner's equipment straps	1113195C	1113196C	1113197C	1113199C



Oil and Gas Full-Body Harness

The ExoFit™ NEX Oil and Gas Full-Body Harnesses combine the industry-first innovations of the ExoFit™ NEX Harness with the additional features developed specifically for the needs of the on- and offshore drilling markets.

Description	Small	Medium	Large	XLarge
18" (45.7 cm) D-ring extension, derrick attachments, hip pad and belt with rigid seat sling	1113295C	1113296C	1113297C	1113298C
18" (45.7 cm) D-ring extension, derrick attachments, quick-connect chest buckle, hip pad and belt with lumbar D-ring and soft seat sling	1113290C	1113291C	1113292C	1113293C



Rope Access and Rescue Harnesses

Complex jobs are easier when your equipment is suited to the task. That's why the ExoFit™ NEX Rope Access and Rescue Harnesses incorporate some of the most advanced technologies in the industry. These multi-use harnesses incorporate specialized designs, components and hardware to optimize rope rescue and industrial rope access work. This makes them ideal for the professional performing rescue and emergency services, industrial rope access and rigging, wind energy and tower maintenance—as well as for arborist activities.

Description	Small	Medium	Large	XLarge
REPEL Technology Webbing, Tech-Lite™ Aluminum Front, Back and Side D-rings, Duo-Lok™ Quick-Connect Buckles and hybrid comfort padding	1113345C	1113346C	1113347C	1113348C
REPEL Technology Webbing, Tech-Lite™ Aluminum Front, Back and Side D-rings, Duo-Lok™ Quick-Connect Buckles and hybrid comfort padding	1113370C	1113371C	1113372C	1113373C



Harnesses

3M™ DBI-SALA® ExoFit™ NEX Arc Flash

Vest-Style Full-Body Harnesses



Description	Small	Medium	Large	XLarge
Nomex®/Kevlar® fibre web, PVC coated aluminum back D-ring, locking quick-connect buckles, comfort padding	1103085C	1103086C	1103087C	1103088C
Nomex®/Kevlar® fibre web, PVC coated aluminum back and side D-rings, locking quick-connect buckles, comfort padding	1103070C	1103071C	1103072C	1103073C
Nomex®/Kevlar® fibre web, dorsal web loop and front rescue loops, locking quick-connect buckles, comfort padding	1113325C	1113326C	1113327C	1113328C
Nomex®/Kevlar® fibre web, PVC coated aluminum front, back and side D-rings, locking quick-connect buckles, comfort padding	1113330C	1113331C	1113332C	1113333C

Construction-Style Harnesses

With integrated hip pad and body belt, these harnesses have excellent tool-carrying capabilities, allow work positioning and provide added back support.

Description	Small	Medium	Large	XLarge
Nomex®/Kevlar® fibre web, PVC coated aluminum back and side D-rings, locking quick-connect buckles, sewn-in hip pad and belt, comfort padding	1113315C	1113316C	1113317C	1113318C

3M™ DBI-SALA® ExoFit™/ExoFit™ Plus

Vest-Style Harnesses

Vest-style harnesses are the most universal, with multiple configurations and connection point options. They're used across a wide variety of industries.



Description	Small	Medium	Large	XLarge
Front and back D-rings, loops for belt, quick-connect buckles	1140007C	1140008C	1140009C	1140010C
Front, back and side D-rings, loops for belt, quick-connect buckles	1140001C	1140002C	1140003C	1140004C
Back D-ring, loops for belt, quick-connect buckles	1140019C	1140020C	1140021C	1140022C
Back and side D-rings, loops for belt, quick-connect buckles	1108575C	1108576C	1108577C	1108581C

3M™ DBI-SALA® ExoFit™

Crossover-Style Harnesses

A front-mounted D-ring makes the crossover-style ideal for ladder climbing and rescue applications.

Description	Small	Medium	Large	XLarge
Front and back D-rings, loops for belt, quick-connect buckles	1108675C	1108676C	1108677C	1108682C
Front, back and side D-rings, loops for belt, quick-connect buckles	1108700C	1108701C	1108702C	1108706C



3M™ DBI-SALA® ExoFit™/ExoFit™ Plus

Construction-Style Harnesses

Made for general construction work, these harnesses have excellent tool-carrying capability, a sewn-in hip pad and removable body belt.

Description	Small	Medium	Large	XLarge
Back D-ring, sewn-in back pad and belt with side D-rings, quick-connect buckles	1140055C	1140056C	1140057C	1140058C
Back D-ring, sewn-in back pad and belt with side D-rings, quick-connect buckles	1108516C	1108517C	1108518C	1108519C



Harnesses

3M™ DBI-SALA® ExoFit™ / ExoFit™ Plus

Wind Energy Harnesses

People around the world rely on our wind industry harnesses because they meet the major global compliance standards including ANSI, OSHA, CSA and CE.



Reinforced lumbar area for added back support. Tool loops allow you to keep your tools close at hand.



Integrated suspension trauma straps minimize suspension trauma after a fall.

Extra tough tubular web encases sub-pelvic webbing for added wear resistance for straddling beams.



Description	Small	Medium	Large	XLarge
ExoFit™ Wind Energy Harness. Quick-connect buckle legs, PVC coated front, back and side D-rings, sewn-in hip pad and belt with tool loops	1102385C	1102386C	1102387C	1102388C
ExoFit™ Wind Energy Harness. Quick-connect buckle legs, PVC coated front, back and side D-rings	1102340C	1102341C	1102342C	1102343C
ExoFit™ Plus Tower Climbing Harness. Front and back D-rings, belt with back pad and side D-rings, removable seat sling with positioning D-rings, quick-connect buckles	1140067C	1140068C	1140069C	1140070C
ExoFit™ Iron Worker's Harness. Back D-ring, sewn-in back pad and belt with side D-rings, reinforced seat straps, tongue buckle legs	1100530C	1100531C	1100532C	1100533C

3M™ DBI-SALA® Delta™

Vest-Style Harnesses

Vest-style harnesses are the most universal, with multiple configurations and connection point options. They're used across a wide variety of industries.



Description	Leg Strap Type			
	Tongue Buckles	Quick-Connect Buckles	Pass-Through Buckles	Parachute buckle leg straps
Back and shoulder D-rings (Universal Size)	1101254C	1110602C	1101781C	–
Back D-ring (Universal Size)	1102000C	1110600C	1103321C	–
Side and back D-ring (Universal Size)	1102008C	1110625C	1103875C	–
Back and front D-rings (Universal Size)	1107807C	1102090C	1112126C	–
Back D-rings (Universal size)	–	–	–	1102001C

3M™ DBI-SALA® Delta™

Construction-Style Harnesses

Made for general construction work, these harnesses have tool-carrying capability, a sewn-in hip pad and removable body belt.



Description	Small	Medium	Large	XLarge	Universal
Back and side D-rings, quick-connect buckle legs and chest strap, belt with sewn-in back pad	1110575C	1110576C	1110577C	1110578C	–
Vest-style, back and side D-rings, belt with sewn-in back and shoulder pads, tongue buckle leg straps	1102201C	1101654C	1101655C	1101656C	–
Front, back and side D-rings, belt and hip pad, tongue buckle leg	1107805C	1107802C	1107801C	1107809C	–
Back D-ring, pass-through buckles, loops for belt (Universal Size)	–	–	–	–	1103513C

Harnesses

3M™ DBI-SALA® Delta™

Crossover-Style Harnesses

A front-mounted D-ring makes the crossover-style ideal for ladder climbing and rescue applications.

Description	Tongue Buckles	Quick-Connect Buckles	Pass-Through Buckles
Back and front D-rings, tongue buckles legs (Universal Size)	1102950C	1110700C	1102010C
Back, front and side D-rings, quick-connect buckles (Universal Size)	1103375C	1110725C	1103270C



1102950C

Description	Small	Medium	Large	XLarge
Front and back D-rings, pass-through legs, belt and hip pad with side D-rings	1101809C	1101810C	1101811C	1101812C

Tower Climbing Harnesses

Description	Small	Medium	Large	XLarge
Vest-style, front and back D-ring, belt with 4" (10.2 cm) wide pad and side D-rings, two tool pouch D-rings, seat sling with positioning D-rings, tongue buckle legs	1107776C	1107777C	1107775C	1107778C
Crossover-style, front D-ring, belt with 4" (10.2 cm) wide pad and side D-rings, two tool pouch D-rings, seat sling with positioning D-rings, tongue buckle legs	1103355C	1103351C	1103350C	1103352C



3M™ DBI-SALA® Delta™

Arc Flash Harnesses

When high voltage electricity is a concern, your safety harness absolutely shouldn't be. That's why every 3M™ DBI-SALA® Delta™ Arc Flash Harness has been tested to perform in accordance with the stringent CSA Z259.10-18 Standard Specification for Personal Climbing Equipment.



Description	Small	Medium	Large	XLarge	Universal
7,000 lb (31.1 kN) nylon web, back web loop, quick-connect buckles, leather insulators, rescue loops	1110788C	1110780C	1110781C	1110782C	-
7,000 lb (31.1 kN) nylon web, back web loop, quick-connect buckles, leather insulators, rescue loops with belt/pad and side D-rings	1110782C	-	-	-	-
Nomex®/Kevlar® fibre web, cross-over style, PVC coated hardware, front, back and side D-rings	-	-	-	-	1110820C
Nomex®/Kevlar® fibre web, PVC coated hardware, back D-ring, pass-through leg straps	-	-	-	-	1110830C

3M™ DBI-SALA® Delta™ Vest

Hi-Vis Reflective and Non-Reflective Workvest Harnesses

Safety is a top priority any time of day. That's why our sleeveless waist-length vests feature a built-in harness for high visibility while working at-height, day or night. They meet CSA Z259.10 for high visibility vests.



Description	Universal
High visibility yellow workvest-style harness, reflective, back D-ring, tongue buckle legs	1107420C
High visibility orange workvest-style harness, reflective, back D-ring, tongue buckle legs	1107404C
Blue cotton workvest-style harness, non-reflective, back D-ring, tongue buckle legs	1107416C

3M™ DBI-SALA® Delta™

Harnesses for Hot Work Use

Stay safe even when things heat up. Featuring heat-resistant and flame-retardant Nomex®/Kevlar® fibre webbing.



Description	Universal
Vest-style, with Nomex®/Kevlar® fibre web, back D-ring, pass-through buckle leg straps, loops for belt	1105475C
Crossover-style, front, back and side D-rings, with Nomex®/Kevlar® fibre web, pass-through buckle leg straps, loops for belt	1104775C
Vest-style, back D-ring, with Nomex®/Kevlar® fibre web, pass-through buckle leg straps, loops for belt	1104625C

Delta™ Resist Webbing Harness

Protect against grease, oil, dirt and grime with integrated Resist Technology (polyurethane coated webbing).

Delta™ Harnesses feature detachable shoulder padding (not shown).



Description	Universal
Vest-style, back D-ring, tongue buckle legs	1110990C

Belts, Workseats and Accessories

3M™ DBI-SALA® Workseats

Bosun Chair

Description	Universal
Bosun chair, 12" x 24" x 1" (30.5 cm x 61 cm x 2.5 cm) board, cushion and side snaps	1001190
Bosun chair only, 12" x 24" x 1" (30.5 cm x 61 cm x 2.5 cm) board	1001140



3M™ DBI-SALA®

Tongue Buckle Belts

Description	Small	Medium	Large	XLarge
Tongue buckle belt with side D-rings, 3" (7.6 cm) pad	1000022C	1000023C	1000024C	1000025C
Delta™ Tongue Buckle Belt with no D-ring and no pad	1000052	1000053	1000054	1000055
Tongue buckle belt with back D-ring, 3" (7.6 cm) pad	1000002C	1000003C	1000004C	1000005C
Tongue buckle belt with floating D-ring, no pad	1000162C	1000163C	1000164C	1000165C
ExoFit™ Tongue Buckle Belt with no D-ring, no pad	1000708	1000709	1000716	1000717



3M™ DBI-SALA®

Lineman Belts

Achieve the maximum in comfort, freedom of movement and ease of use with our ergonomically designed belts.



3M™ DBI-SALA®

Suspension Trauma Safety Straps

Relief. It can make a big difference when you're suspended in your safety harness. It's why every worker should be equipped with suspension trauma safety straps. They easily deploy and hook together in seconds, allowing a suspended worker to stand up in harness with one or both feet to relieve downward pressure. They're compact, lightweight and compatible with most harness brands in the field.



Description	Universal
Suspension trauma safety straps, one pair, connects to most harnesses	9501403C
Flame-resistant suspension trauma safety straps, one pair, connects to most harnesses	9505712

3M™ DBI-SALA®

Harness and Lanyard Bag

Description	Universal
3M™ DBI-SALA® Bag 7-½" wide x 6-½" deep x 15-½" long (19 cm x 16.5 cm x 39.4 cm), holds a harness and lanyard or 50 ft. (15.2 m) of ¾" (0.6 cm) rope	9511597



Belts, Workseats and Accessories

3M™ DBI-SALA®

Accessories

Description	Image	Universal
Pouch with belt loops and clip with Velcro closure (blue colour)		5900891
Attachment breakaway lanyard keeper plastic ring with Velcro used to “park” lanyard when not in use. Qty. 2		9511632
Foam Shoulder Pad Sold one each, two required per harness		9502006
D-ring Extension with D-ring at one end, snap hook at other x 18" (46 cm)		1231117C
3M™ DBI-SALA® Delta™ Comfort Pad attaches to most harnesses to provide wrap-around comfort		9501207
Lumbar Wear Pads Removable lumbar wear pad for 3M™ DBI-SALA® ExoFit™ NEX Wind Energy Harness Belt (Large, XLarge, XXLarge)		9505515



Energy-Absorbing Lanyards

Energy-Absorbing Lanyards

Built for exceptional performance and meeting industry standards.

When you place your trust in a 3M™ DBI-SALA® Lanyard, you can depend on the fact that each one meets rigorous industry safety standards including CSA Z259.11-17 in Canada. That's why workers rely on them for safety, ease-of-use and durability.

Choosing a Lanyard.

Look for these quality features when selecting your lanyard.

1 Webbing

Choose your webbing based on the conditions you work in. Along with polyester and nylon webbing, optional choices include Kevlar/Nomex web, polyurethane coated webs and even wire-rope (cable).

2 Impact indicators

Impact indicators let you know if an energy absorber has been involved in a fall or impacted, so it can be removed from service.

3 Connectors/hooks

3M™ DBI-SALA® Connectors allow one-handed connections without pinching thumbs or fingers.

4 Energy absorber

Energy absorbers keep impact loads to the user below allowable limits and are available in pack or tubular styles.

5 Length

Lanyards are available in the standard 1.8 m lengths, but other lengths are available.



Types of Lanyards



Pack-Style Energy-Absorbing Lanyards

These basic lanyards include a pack-style energy absorber and offer a variety of leg types (web, cable, or with Kevlar® fibre). They dissipate energy, limiting the forces on your body during a fall.



Tubular-Style Energy-Absorbing Lanyards

These lanyards feature an internal energy absorber that dissipates the energy of a fall. This style is available in both a traditional fixed length design and a “stretch” style that expands and contracts.



Twin-Leg Lanyards

Two lanyards that are connected at one end. This style of lanyard is used to provide 100% tie-off, allowing you to stay protected when moving from one location to another.



Positioning Lanyards

Lanyards without energy absorbers, such as rope or web lanyards and chain rebar assemblies, are designed for positioning or restraint applications.



Steel and aluminum rebar lock hooks

Patent-pending, locking gate/nose design for maximum strength and security.

Fits around most structures with a 2-1/2" (63.5 mm) gate opening to maximize inner diameter.



Ergonomic design for enhanced functionality and to better fit in the palm of your hand.

Workers prefer 3M™ DBI-SALA® Snap Hooks.



9502116

One-handed operation makes our Snap Hooks the most popular in the industry. You can operate them with your gloves on or off, all without your fingers getting in the way!

All our lanyards feature 3,600 lb. (16 kN) rated gates, meeting rigorous CSA standards.

Lanyard hook options

9502116 Standard Hook

3/4" (19 mm) gate opening – 3,600 lb. (16 kN) gate strength.

9502058 Aluminum Rebar Hook

2-1/4" (57 mm) gate opening – 3,600 lb. (16 kN) gate strength.

2109193 Flat Steel Rebar Hook

2-1/2" (63.5 mm) gate opening – 3,600 lb. (16 kN) gate strength.

2000125 Saflok™ Max Steel Rebar Hook

3" (76.2 mm) gate opening – 3,600 lb. (16 kN) gate strength.



2000194 Saflok™ Tower Hook

4-5/16" (116.8 mm) gate opening – 1600 lb. (16 kN) gate strength.



2000209 Aluminum Rebar Lock Hook

2-1/2" (63.5 mm) gate opening – 3,600 lb. (16 kN) gate strength.



2000210 Steel Rebar Lock Hook

2-1/2" (63.5 mm) gate opening – 3,600 lb. (16 kN) gate strength.



2000113 Saflok™ Steel Carabiner

1-3/16" (30 mm) gate opening – 3,600 lb. (16 kN) gate strength.



2000114 Saflok™ Steel Carabiner

2-3/16" (55.5 mm) gate opening – 3,600 lb. (16 kN) gate strength.



Specialty Lanyards



Lanyards for Arc Flash and Hot Work Use

Special material with Kevlar® fibre provides exceptional cut resistance and is ideal for high temperature environments or those requiring arc flash protection.



Lanyards for Foot-level Tie-Off

These lanyards can be used at your feet, allowing a 12' (3.7 m) free fall and maintaining forces below 1,800 lb. (8 kN). Also use for 6' (1.8 m) falls for heavier workers up to 420 lb. (190 kg).



Fall-Restricting Device

Unique device cinches around a wood pole during a "cut out" preventing user from falling to the ground and allowing user to regain footing.

Personal energy absorbers and lanyards:

how the changes to CSA Standard Z259.11-17 affect you and your workers.

Jobs change. Technology improves. Equipment evolves. All of these developments lead to changes in standards.

The CSA Group, one of the largest standards development organizations in North America and a leader in safety certification in Canada and the US, released updated standards in 2017 for personal energy absorbers and lanyards. Standard Z259.11-17 still focuses on industrial and commercial products for fall arrest, but has revisions from the previous version, published in 2005.

What's changing and how do these changes affect workers?

Updates to instructions for use

The most important updates for users of fall protection equipment and their employers are in the instructions for use (section 7 in the 2017 standard). In addition to the information found in the previous standard, the updated standard includes new information on the selection, use and lifespan of fall protection gear, especially energy-absorbing lanyards and horizontal lifelines.

Manufacturers will now be required to include a table, chart or graphic in equipment manuals illustrating the use of energy absorbers based on the user's weight and free-fall distance; this illustration will specify the complete range of weights and distances permitted for the device (N.B. the free-fall distance is defined as the vertical distance travelled by a worker or test mass from the start of a free fall to the initiation of an arresting force).

These factors will be of paramount importance for selecting the correct products for the job. In addition to physical job requirements, the user will also have to consider weight and free-fall distance when selecting lanyard length, and factor them into the clearance requirements. It will be crucial for manufacturers to create user instructions and images that are clear and easy to understand.

Manufacturers must include a published value for maximum deployment (X_{max}) and average arrest force (F_{avg}). Parameters for these values are in the standard. The labels for energy absorbers must have performance factor data (discussed below).



Manufacturers will now be required to make end-of-service recommendations for their equipment.

The 2017 standard also includes updates to the design requirements for energy absorbers and lanyards.



Energy absorber design and performance

Energy absorber performance (also referred to as “P factor”) is now calculated using the following factors:

- | | |
|---|--|
|  <p>① User’s mass, which is based on a range of masses determined by the manufacturer</p> |  <p>③ An average deceleration of more than or equal to 2.3 g and less than or equal to 7 g</p> |
|  <p>② Maximum deceleration of 10 g, where $g=9.81 \text{ m/s}^2$</p> |  <p>④ A range of 8-10 g for a total period of less than 0.1 s</p> |

Minimum breaking strength has been reduced to 16 kN (3600 lbf) when tested per the standard. This new calculation significantly changes how an energy absorber can be tested and used. In the previous standard, the mass free fall was based on a maximum user mass. In the updated standard, the energy absorber’s use is based on the user mass and the free-fall distance. The test mass is now constructed to meet the maximum-rated capacity of the energy absorber, and the upper range of testing temperature has been increased to 45°C.

Lanyard design and classification

In the 2017 standard, lanyard classifications now include a new class named Class Y, bringing the total number of lanyard classes to seven. Class Y includes lanyards that are also often referred to as 100% tie-off lanyards or two-legged lanyards.

The Class Y lanyard has three connectors—two Class 1 connectors to the anchorage and one class connector or soft loop at the body—and, per the Standard, has an energy absorber. This update could cause an issue when a user integrates a Y-lanyard without an energy absorber into a harness equipped with an energy absorber attached to the dorsal D-ring on the harness.

Lanyard design and classification cont.

Other changes to lanyard classification include the requirement that Class C—wire rope lanyards—have a clear covering on mechanical sleeves to allow for more accurate inspection. Class D lanyards are now better defined as lineman’s pole straps.

Smart workers and employers keep up with all the advancements to remove as much danger as possible from work at heights. So does 3M. As work and worksites change, and CSA standards advance to meet these changes, you can rely on 3M Fall Protection Products to continue to evolve and improve to help keep you safe, no matter the work or the working conditions.

Visit [3M.ca/FallProtection](https://www.3m.ca/FallProtection) to learn more about personal energy absorbers and lanyards.

A new standard for lanyard-manufacturing has been introduced in Canada.

CSA Z259.11-17 has introduced a number of changes to the testing and manufacture of lanyards which will affect how you buy the product.

The main change to buying lanyards is their capacity. The standard E4 and E6 configurations will disappear and manufacturers will introduce various weight ranges from which to choose. Most manufacturers will keep these ranges to a minimum and 3M DBI-SALA will offer 3 versions (55-140 kg, 60-115 kg, 80-190 kg).

Another major change allows for free fall distances that exceed the original 1.8 m (6 feet) previously tested. This will allow lanyards to be tested where a user might have to tie-off below their D-ring or at their feet. Where this lanyard is selected, the user will have to pay attention to changes in the clearance distance (because it will be longer) which will be provided on the label. The label itself will

be standardized for all manufacturers to help reduce confusion in the marketplace.

Clockwise from the top left corner the label provides the following information:

- Quad. 1.** – Maximum free fall distance for the specific lanyard model.
- Quad. 2.** – The allowable user weight range.
- Quad. 3.** – The maximum deployment the lanyard based on the free fall distance in Quad. 1 at the weight range specified.
- Quad. 4.** – Depicts the deployment factor. This number can be used to calculate deployment distances where a shorter clearance distance is a factor during use. This calculation is reviewed in the user instruction manual and should be left to an engineer or other qualified person.

Energy-Absorbing Lanyards

3M™ DBI-SALA® ShockWave2

Energy-Absorbing Lanyards

Avoid trips and snags on the job with ShockWave2. It's uniquely designed to expand and contract (1.8-1.4 m) in reaction to a worker's movements, and the tubular web stays out of your way when not in use. A built-in impact indicator provides easy visual evidence if the energy has been impact loaded through a fall or improper use. It limits the average fall arresting forces to 900 lb. (4 kN)

ShockWave2 Energy-Absorbing Lanyards

Description	Min.	Max.	Part #
ShockWave2 Lanyard with single-leg with snap hook and steel rebar hook x 6' (1.8 m)	60 kg	115 kg	1244321C
ShockWave2 Twin-Leg Lanyard with snap hook and aluminum rebar hooks on leg ends x 6' (1.8 m)	60 kg	115 kg	1244306C



3M™ DBI-SALA®

Web Loop Lanyard

Simply choke off to back D-ring or to dorsal web loop. Reduces weight and is ideal for electrical applications where no metal above the waist is preferred.

Description	Min.	Max.	Part #
3M™ DBI-SALA® ShockWave2 Web Loop Lanyard single-leg with snap hook at one end and web loop at the other x 6' (1.8 m)	60 kg	115 kg	1244310C



Energy-Absorbing Lanyards

3M™ DBI-SALA®

Arc Flash Lanyards

Constructed from unique materials, these lanyards have Nomex®/Kevlar® fibre and are ideal for high heat environments or for electrical work when arc flash is a concern. Meets arc requirements of ASTM F887.



Description	Min.	Max.	Part #
3M™ DBI-SALA® ShockWave2 Arc Flash Lanyard with Nomex®/Kevlar® fibre single-leg with snap hooks x 6' (1.8 m)	60 kg	115 kg	1244610C

3M™ DBI-SALA®

EZ-Stop™ Energy-Absorbing Lanyards

EZ-Stop™ Lanyards use a controlled tearing action when subjected to fall arrest forces. They limit the average arresting forces to 809 lb (3.6 kN) or less. These lanyards feature 1" (2.5 cm) polyester web construction (unless specified differently), double locking snap hooks, a durable nylon energy absorber cover and various lengths and hook options to fit your job.

Single-Leg Lanyards



Description	Min.	Max.	Part #
3M™ DBI-SALA® EZ-Stop™ Lanyard Single-leg with snap hooks at each end x 6' (1.8 m)	55 kg	140 kg	1246011C
3M™ DBI-SALA® EZ-Stop™ Lanyard Elastic leg, 1" (2.5 cm) web, snap hooks at ends, x 6' (1.8 m)	55 kg	140 kg	1246200C
3M™ DBI-SALA® EZ-Stop™ Single-Leg Lanyard Snap hook and Saflok Max Hook x 6' (1.8 m)	55 kg	140 kg	1246101C
3M™ DBI-SALA® EZ-Stop™ Energy Absorber add in-line to a non-energy absorbing lanyard for fall arrest applications. Snap hook at one end, D-ring at other x 14.5" (36.8 cm)	55 kg	140 kg	1246177C
3M™ DBI-SALA® EZ-Stop™ Lanyard with 6' (1.8 m) web single-leg with aluminum snap hook at one end, aluminum comfort grip rebar hook at leg end	80 kg	190 kg	1246437C

Twin-Leg Lanyards

Description	Min.	Max.	Part #
3M™ DBI-SALA® EZ-Stop™ Twin-Leg Lanyard snap hooks at each end x 6' (1.8 m)	55 kg	140 kg	1246022C
3M™ DBI-SALA® EZ-Stop™ Twin-Leg Lanyard with elastic leg and snap hooks at each end x 6' (1.8 m)	55 kg	140 kg	1246196C
3M™ DBI-SALA® EZ-Stop™ Twin-Leg Lanyard with aluminum snap hook and aluminum rebar hooks at leg ends x 6' (1.8 m)	55 kg	140 kg	1246021C
3M™ DBI-SALA® EZ-Stop™ Twin-Leg Lanyard with snap hook and steel rebar hooks at leg ends x 6' (1.8 m)	55 kg	140 kg	1246024C
3M™ DBI-SALA® EZ-Stop™ Twin-Leg Lanyard with snap hook at one end, Saflok™ Max Steel Rebar Hook (7.6 cm gate opening) at leg ends x 6' (1.8 m)	55 kg	140 kg	1246113C
3M™ DBI-SALA® EZ-Stop™ Lanyard with elastic legs, aluminum snap hook and aluminum rebar hooks at leg ends x 6' (1.8 m)	55 kg	140 kg	1246193C
3M™ DBI-SALA® EZ-Stop™ 100% Tie-Off Shock Absorbing Lanyard with snap hooks at each end, 6' (1.8 m)	80 kg	190 kg	1246114C
3M™ DBI-SALA® EZ-Stop™ 100% Tie-Off Shock Absorbing Lanyard with steel rebar hooks at both ends, 6' (1.8 m)	80 kg	190 kg	1246193C



3M™ DBI-SALA® EZ-Stop™ Resist Lanyards



Description	Min.	Max.	Part #
3M™ DBI-SALA® EZ-Stop™ Resist Lanyard with Single-leg polyurethane coated web, snap hooks x 6' (1.8 m)	55 kg	140 kg	1246226C
3M™ DBI-SALA® EZ-Stop™ Resist Lanyard with Single-leg polyurethane coated web, snap hook and rebar hook x 6' (1.8 m)	55 kg	140 kg	1246224C
3M™ DBI-SALA® EZ-Stop™ Resist Lanyard with Single-leg polyurethane coated web, snap hooks x 4' (1.2 m)	55 kg	140 kg	1246225C

Energy-Absorbing Lanyards

3M™ DBI-SALA® EZ-Stop™

Lanyards for Arc Flash and Hot Work Use

Constructed from unique materials, these lanyards are ideal for high heat environments or for electrical work when arc flash is a concern. Meets arc requirements of ASTM F887.

Description	Min.	Max.	Part #
3M™ DBI-SALA® EZ-Stop™ Arc Flash Lanyard with single-leg Nomex®/Kevlar® fibre web with snap hooks x 6' (1.8 m)	55 kg	140 kg	1246306C
3M™ DBI-SALA® EZ-Stop™ Arc Flash Lanyard with adjustable web twin-leg Force2, Nomex®/Kevlar® fibre webbing and shock pack, aluminum snap hook at centre and Saflok™ Tower Hooks at leg ends x 6' (1.8 m)	–	–	1246352C
3M™ DBI-SALA® EZ-Stop™ Arc Flash Lanyard with twin-leg Force2 with adjustable Nomex®/Kevlar® fibre webbing, aluminum snap hook and aluminum rebar hooks at leg ends x 6' (1.8 m)	–	–	1246321
3M™ DBI-SALA® EZ-Stop™ Arc Flash Lanyard with twin-leg Force2 with adjustable Nomex®/Kevlar® fibre webbing and snap hooks at ends x 6' (1.8 m)	–	–	1246320C
3M™ DBI-SALA® EZ-Stop™ Arc Flash Lanyard with polyurethane coated web, web loop at one end, snap hook at the other end x 6' (1.8 m)	–	–	1246310C
3M™ DBI-SALA® EZ-Stop™ Arc Flash Lanyard with Force2 with Nomex®/Kevlar® fibre adjustable webbing and aluminum snap hook at one end and aluminum rebar hook at the other end x 6' (1.8 m)	–	–	1246318C



3M™ DBI-SALA® EZ-Stop™

Retrax™ Lanyards

Unique spring technology retracts and expands from 2-½'-6' (0.8 m-1.8 m) in reaction to user's movements.

Description	Min.	Max.	Part #
3M™ DBI-SALA® EZ-Stop™ Retrax™ Lanyard with twin-leg with snap hooks at each end x 6' (1.8 m)	55 kg	140 kg	1241480C
3M™ DBI-SALA® EZ-Stop™ Retrax™ Lanyard with single-leg with snap hooks at each end x 6' (1.8 m)	55 kg	140 kg	1241460C



3M™ DBI-SALA® EZ-Stop™

Leading Edge Energy-Absorbing Lanyards

Engineered for sharp edges, these lanyards incorporate edge certified cable construction and offer Force2 foot-level tie-off ability (for maximum 3.6 m free fall).



Description	Min.	Max.	Part #
3M™ DBI-SALA® EZ-Stop™ Leading Edge Lanyard with Single-leg with snap hooks at each end x 6' (1.8 m)	73 kg	140 kg	1246066C
3M™ DBI-SALA® EZ-Stop™ Retrax™ Lanyard with twin-leg with aluminum snap hook at centre and aluminum locking rebar hooks at leg ends x 6' (1.8 m)	–	–	1246178C
3M™ DBI-SALA® EZ-Stop™ Leading Edge Lanyard with single-leg with snap hook at one end, steel rebar hook at the other end x 6' (1.8 m)	–	–	1246261C
3M™ DBI-SALA® EZ-Stop™ Leading Edge Lanyard twin-leg with aluminum snap hooks at centre and at each leg x 6' (1.8 m)	–	–	1246068C

3M™ DBI-SALA® Force2

Energy-Absorbing Lanyards

Ideal when there is no overhead anchorage and your only option is to tie off at your feet, these lanyards limit average forces below 1,800 lb. (8 kN) It can be used as a standard lanyard up to a 6' (1.8 m) free fall for workers that require a capacity of 311 lb. - 420 lb. (141 kg - 190 kg)

Description	Min.	Max.	Part #
3M™ DBI-SALA® Force2 Lanyard with single leg and snap hooks at each end x 6' (1.8 m)	73 kg	140 kg	1246167C
3M™ DBI-SALA® Force2 Lanyard with twin-leg and flat steel rebar hooks at leg ends x 6' (1.8 m)	–	–	1246159C
3M™ DBI-SALA® Force2 Lanyard with twin-leg and snap hooks at each end x 6' (1.8 m)	–	–	1246161C
3M™ DBI-SALA® Force2 Lanyard with single-leg and snap hook at one end, aluminum comfort grip rebar hook at leg end x 6' (1.8 m)	–	–	1246414
3M™ DBI-SALA® Force2 Lanyard with snap hook at one end, Saflok™ Max Steel Rebar Hook (7.6 cm gate opening) at leg ends x 6' (1.8 m)	–	–	1246143
3M™ DBI-SALA® Force2 Energy Absorber only, snap hook on one end, D-ring on other end x 1.4' (0.4 m)	–	–	1246130C
3M™ DBI-SALA® Force2 Lanyard with twin-leg and snap hook at one end, Aluminum Comfort Grip Rebar Hook at leg ends x 6' (1.8 m)	–	–	1246413
3M™ DBI-SALA® Force2 Lanyard with elastic legs, aluminum snap hooks and aluminum rebar hooks x 6 (1.8m)	–	–	1246145C
3M™ DBI-SALA® Force2 Lanyard with snap hook at one end, aluminum comfort grip Rebar Hook at leg ends x 6' (1.8 m)	–	–	1246415
3M™ DBI-SALA® Force2 Lanyard with twin-leg, rope legs, steel rebar hooks x 6' (1.8 m)	–	–	1246272
3M™ DBI-SALA® Force2 Lanyard with twin-leg, elastic webbing with snap hooks at ends x 6' (1.8 m)	–	–	1246147
3M™ DBI-SALA® Force2 Lanyard rope, twin-leg, aluminum snap hook at one end, aluminum rebar (6.4 cm gate opening) at ends x 6' (1.8 m)	–	–	1246273



Energy-Absorbing Lanyards

3M™ DBI-SALA® Force2

Wind Energy Lanyards



Description	Min.	Max.	Part #
3M™ DBI-SALA® Force2 Wind Energy Lanyard with twin-leg elastic web, snap hook and aluminum rebar hooks at leg ends, integrated rescue D-rings x 6' (1.8 m)	67 kg	140 kg	1246153*
3M™ DBI-SALA® Force2 Wind Energy Lanyard with twin-leg elastic web, snap hook and Saflok™ Max Hooks on leg ends, integrated rescue D-rings x 6' (1.8 m)	67 kg	140 kg	1246152C

*Not CSA approved.

3M™ DBI-SALA®

Trigger X Tie-Back Adjustable Rope Positioning Lanyard

Get the versatility you need with the 3M™ DBI-SALA® Trigger X Adjustable Rope Positioning Lanyard. This CSA rated positioning lanyard has three work modes and is available in multiple configurations. Smooth and precise adjustments on the abrasion resistant rope put you in a position to succeed.



Description	6'	8'
3M™ DBI-SALA® Rebar Hook, Blue, CSA	1234107C, 1234105C	1234103C, 1234102C
3M™ DBI-SALA® Snap Hook, Blue, CSA	1234106C	1234104C



Positioning Lanyards

3M™ DBI-SALA®

Positioning Web Lanyards

Lanyards without energy absorbers, such as rope or web lanyards and chain rebar assemblies, are designed for positioning or restraint applications. 1" (2.5 cm) polyester web construction for durability that will last. Available in various lengths.

Description	Min.	Max.	Part #
3M™ DBI-SALA® Positioning Web Lanyard single-leg with 1" (2.5 cm) polyester web, adjustable length and snap hooks at each end x 6' (1.8 m)	4	6	1231016C
3M™ DBI-SALA® Positioning Web Lanyard single-leg with 1" (2.5 cm) polyester web and snap hooks at each end x 6' (1.8 m)	–	6	1231106C
3M™ DBI-SALA® Positioning Web Lanyard single-leg with 1" (2.5 cm) polyester web and snap hooks x 4' (1.2 m)	–	4	1231104C
3M™ DBI-SALA® D-ring Extension is single-leg with 1" (2.5 cm) polyester web and snap hooks x 1.5' (0.46 m)	–	1.5	1231117C



Adjustable Rope Positioning Lanyards

Description	Min.	Max.	Part #
Adjustable rope positioning lanyard with rope adjuster and aluminum carabiners on ends x 8' (2.4 m)	–	–	1234080
Adjustable rope positioning lanyard with rope adjuster and aluminum snap hook on one end and carabiner on the other x 8' (2.4 m)	–	–	1234071
Adjustable rope positioning lanyard with rope adjuster and steel snap hook on one end and carabiner on the other x 8' (2.4 m)	–	–	1234070



3M™ DBI-SALA®

Chain and Web Rebar Positioning Lanyards

Made of twist link chain or polyester web for strength and durability. A variety of hook options provide a safe and compatible connection to many types of structures.

Description	Part #
3M™ DBI-SALA® Chain Rebar Lanyard, chain rebar assembly with snap hooks and swiveling flat steel rebar hook at centre x 20.5" (52 cm)	5920050
3M™ DBI-SALA® Chain Rebar Lanyard, chain rebar assembly with snap hooks and aluminum rebar hook at centre x 20.5" (52 cm)	5920080
3M™ DBI-SALA® Chain Rebar Lanyard, chain rebar assembly with swiveling Saflok Max steel rebar hook and Zorbit™ at centre, snap hooks at leg end x 26.5" (0.6 m)	5920200C*
3M™ DBI-SALA® Chain Rebar Lanyard, chain rebar assembly with swiveling Saflok Max steel rebar hook and Zorbit™ at centre, snap hooks at leg ends x 26.5" (0.6 m)	5920201C*
3M™ DBI-SALA® Web Rebar Assembly, with snap hooks and aluminum rebar hook at centre x 18" (45 cm)	1231380
3M™ DBI-SALA® Spreader Hook, Use with large carabiner to form a positioning assembly that is short and compact. Steel hooks with self-locking/closing 3,600 lb. (16 kN) gates	2108403

*Only "C"-marked items are CSA certified.



3M™ DBI-SALA® Cynch-Lok™

Fall-Restricting Devices

Real world challenges demand real world solutions. That's why we worked directly with actual pole climbers to develop Cynch-Lok™ Fall-Restricting Devices. You can effortlessly adjust and cinch it around the pole during a "cut-out" and easily hitch-hike poles (move or jump the strap upwards past obstacles) with a hand position that's comfortable.

Exterior straps can easily be swapped out in the field depending on pole size, eliminating the need for multiple systems. Cynch-Lok™ meets CSA Z259.14 standards for Type A and AB (dry, wet and icy poles) and ASTM F887.

3M™ DBI-SALA® Cynch-Lok™

Webs and Ropes



Description	Distribution Poles Sizes		Part #
	Min. (dia/circ)	Max. (dia/circ)	
3M™ DBI-SALA® Cynch-Lok™ Rope for Distribution Poles, weight: 4.8 lb. (2.1 kg)	5-½"/17-½" (14 cm/44.4 cm)	18-½"/58" (20.3 cm/147.3 cm)	1204057
3M™ DBI-SALA® Cynch-Lok™ Rope for Transmission Poles, weight: 5.3 lb. (2.4 kg)	5-½"/17-½" (14 cm/44.4 cm)	30-½"/96" (77.5 cm/243.8 cm)	1204058
3M™ DBI-SALA® Cynch-Lok™ Web for Transmission Poles, weight: 4.9 lb. (2.4 kg)	5-½"/17-½" (14 cm/44.4 cm)	30-½"/96" (77.5 cm/243.8 cm)	1204076

Replacement Components



Description	Distribution Poles Sizes		Part #
	Min. (dia/circ)	Max. (dia/circ)	
3M™ DBI-SALA® Cynch-Lok™ Replacement Strap for Distribution Poles, pole size (dia/circ): min 5-½"/17-½" (14 cm/44.4 cm)-max 18-½"/58" (20.3 cm/147.3 cm), weight: 1.9 lb. (0.86 kg)	5-½"/17-½" (14 cm/44.4 cm)	18-½"/58" (20.3 cm/147.3 cm)	1200110
3M™ DBI-SALA® Cynch-Lok™ Replacement Strap for Transmission Poles, pole size (dia/circ): min 5-½"/17-½" (14 cm/44.4 cm)-max 30-½"/96" (20.3 cm/147.3 cm), weight: 2.4 lb. (1.1 kg)	5-½"/17-½" (14 cm/44.4 cm)	30-½"/96" (20.3 cm/147.3 cm)	1200111
3M™ DBI-SALA® Cynch-Lok™ Replacement Rope Interior Strap, weight: 2.9 lb.	-	-	1200115
3M™ DBI-SALA® Cynch-Lok™ Replacement Web Interior Strap, weight: 2.9 lb.	-	-	1200136
3M™ DBI-SALA® Cynch-Lok™ Left Carabiner Conversion Kit – Web	-	-	1204077
3M™ DBI-SALA® Cynch-Lok™ Left Carabiner Conversion Kit – Rope	-	-	1204074



Self-Retracting Lifelines

Self-Retracting Lifelines

**Leadership at heights.
Applied to harnessing safety
through science.**

When there's nothing between you and the ground, you need a reliable, advanced Self-Retracting Lifeline (SRL) to have your back, every time. We developed the world's first SRL over 60 years ago and have continued to create innovative advances in lifeline systems that are used globally.

We've pioneered many industry-firsts, including the 3M™ DBI-SALA® Nano-Lok™ edge Self-Retracting Lifeline, which is specifically designed for foot level tie-off and sharp edge applications often found in construction. As an industry leader in SRLs, we know the importance of ergonomic design and ease-of-use for direct connection to most harnesses.

Whether your application requires single or twin-leg configurations, mounting to an overhead anchor or for connection directly to the harness, there are numerous models available for nearly every application.



3M™ DBI-SALA® Nano-Lok™

Self-Retracting Lifeline

Keep safe while hardly noticing you're wearing an SRL at all. The Nano-Lok SRL is ergonomically designed for ease-of-use and is ideal for direct connection to most harnesses. It stays out of the way and can be easily used as a lanyard replacement. Nano-Lok™ SRL Locks quickly—stopping a fall within inches. In addition, tension is always kept on the lifeline, which reduces dragging, snapping and trip falls.



3100496: twin pin connector

1 Twin-leg anchorage connector

Attach two SRLs directly to back of most harnesses; installs to web—leaves dorsal D-ring open for other equipment or rescue; design provides snug fit to worker's back; interchangeable SRLs allow versatility and replacement options.

2 Centrifugal brake

Stops falling worker within inches — reduces fall distances and average arresting forces to 900 lb (4 kN) or less; replaces lanyard and improves safety.

3 Impact-resistant housing

High-strength housing provides maximum durability.

4 Impact indicator

Integrated energy absorber provides visual indication of a fall.

5 RFID equipped

Helps track equipment and manage safety inspection programs.



3101313

- Extremely compact and lightweight
- 420 lb (190.5 kg) weight capacity
- Wide variety of configurations

Direct-to-harness connection

Single-Leg or twin-leg connectors install underneath the webbing on most harnesses.

- Leaves D-ring open for other equipment or rescue.
- Provides snug fit to workers back—eliminates nuisance flopping.
- Lower attachment point keeps housing at shoulder level vs. head level.



3101600



3101678



3101628



3100274

Fall protection system provides audible and visual alert of worker tie off status, Length: 11 ft (3.35 m)

3M™ DBI-SALA® Nano-Lok™

Self-Retracting Lifelines

Gate opening Gate strength	Anchorage type			Lifeline hook options								Part		
	New Nano-Lok™ Single Pin Connector 3100493	Steel carabiner 2000112	Alum. carabiner 2000025	No connector included	3/4 in (19 mm) 3,600 lb (16 kN)	3/4 in (19 mm) 3,600 lb (16 kN)	3/4 in (19 mm) 3,600 lb (16 kN)	2-1/4 in (57 mm) 3,600 lb (16 kN)	2-1/2 in (62.5 mm) 3,600 lb (16 kN)	2-1/2 in (62.5 mm) 3,600 lb (16 kN)	2-1/2 in (62.5 mm) 3,600 lb (16 kN)		2-1/4 in (57 mm) 3,600 lb (16 kN)	
CSA approved	Single-leg	<input type="checkbox"/>	<input type="checkbox"/>	<input type="checkbox"/>	<input type="checkbox"/>	<input type="checkbox"/>	<input type="checkbox"/>	<input type="checkbox"/>	<input type="checkbox"/>	<input type="checkbox"/>	<input type="checkbox"/>	<input type="checkbox"/>	3101223	
		<input type="checkbox"/>	<input type="checkbox"/>	<input type="checkbox"/>	<input type="checkbox"/>	<input type="checkbox"/>	<input type="checkbox"/>	<input type="checkbox"/>	<input type="checkbox"/>	<input type="checkbox"/>	<input type="checkbox"/>	<input type="checkbox"/>	<input type="checkbox"/>	3101231
		<input type="checkbox"/>	<input type="checkbox"/>	<input type="checkbox"/>	<input type="checkbox"/>	<input type="checkbox"/>	<input type="checkbox"/>	<input type="checkbox"/>	<input type="checkbox"/>	<input type="checkbox"/>	<input type="checkbox"/>	<input type="checkbox"/>	<input type="checkbox"/>	3101213
		<input type="checkbox"/>	<input type="checkbox"/>	<input type="checkbox"/>	<input type="checkbox"/>	<input type="checkbox"/>	<input type="checkbox"/>	<input type="checkbox"/>	<input type="checkbox"/>	<input type="checkbox"/>	<input type="checkbox"/>	<input type="checkbox"/>	<input type="checkbox"/>	3101232
		<input type="checkbox"/>	<input type="checkbox"/>	<input type="checkbox"/>	<input type="checkbox"/>	<input type="checkbox"/>	<input type="checkbox"/>	<input type="checkbox"/>	<input type="checkbox"/>	<input type="checkbox"/>	<input type="checkbox"/>	<input type="checkbox"/>	<input type="checkbox"/>	3101234
		<input type="checkbox"/>	<input type="checkbox"/>	<input type="checkbox"/>	<input type="checkbox"/>	<input type="checkbox"/>	<input type="checkbox"/>	<input type="checkbox"/>	<input type="checkbox"/>	<input type="checkbox"/>	<input type="checkbox"/>	<input type="checkbox"/>	<input type="checkbox"/>	3101301
		<input type="checkbox"/>	<input type="checkbox"/>	<input type="checkbox"/>	<input type="checkbox"/>	<input type="checkbox"/>	<input type="checkbox"/>	<input type="checkbox"/>	<input type="checkbox"/>	<input type="checkbox"/>	<input type="checkbox"/>	<input type="checkbox"/>	<input type="checkbox"/>	3101671
		<input type="checkbox"/>	<input type="checkbox"/>	<input type="checkbox"/>	<input type="checkbox"/>	<input type="checkbox"/>	<input type="checkbox"/>	<input type="checkbox"/>	<input type="checkbox"/>	<input type="checkbox"/>	<input type="checkbox"/>	<input type="checkbox"/>	<input type="checkbox"/>	3101245
		<input type="checkbox"/>	<input type="checkbox"/>	<input type="checkbox"/>	<input type="checkbox"/>	<input type="checkbox"/>	<input type="checkbox"/>	<input type="checkbox"/>	<input type="checkbox"/>	<input type="checkbox"/>	<input type="checkbox"/>	<input type="checkbox"/>	<input type="checkbox"/>	3101220
		<input type="checkbox"/>	<input type="checkbox"/>	<input type="checkbox"/>	<input type="checkbox"/>	<input type="checkbox"/>	<input type="checkbox"/>	<input type="checkbox"/>	<input type="checkbox"/>	<input type="checkbox"/>	<input type="checkbox"/>	<input type="checkbox"/>	<input type="checkbox"/>	3101246
	Twin-leg	<input type="checkbox"/>	<input type="checkbox"/>	<input type="checkbox"/>	<input type="checkbox"/>	<input type="checkbox"/>	<input type="checkbox"/>	<input type="checkbox"/>	<input type="checkbox"/>	<input type="checkbox"/>	<input type="checkbox"/>	<input type="checkbox"/>	<input type="checkbox"/>	3101247
		<input type="checkbox"/>	<input type="checkbox"/>	<input type="checkbox"/>	<input type="checkbox"/>	<input type="checkbox"/>	<input type="checkbox"/>	<input type="checkbox"/>	<input type="checkbox"/>	<input type="checkbox"/>	<input type="checkbox"/>	<input type="checkbox"/>	<input type="checkbox"/>	3101222
		<input type="checkbox"/>	<input type="checkbox"/>	<input type="checkbox"/>	<input type="checkbox"/>	<input type="checkbox"/>	<input type="checkbox"/>	<input type="checkbox"/>	<input type="checkbox"/>	<input type="checkbox"/>	<input type="checkbox"/>	<input type="checkbox"/>	<input type="checkbox"/>	3101308
		<input type="checkbox"/>	<input type="checkbox"/>	<input type="checkbox"/>	<input type="checkbox"/>	<input type="checkbox"/>	<input type="checkbox"/>	<input type="checkbox"/>	<input type="checkbox"/>	<input type="checkbox"/>	<input type="checkbox"/>	<input type="checkbox"/>	<input type="checkbox"/>	3101257
		<input type="checkbox"/>	<input type="checkbox"/>	<input type="checkbox"/>	<input type="checkbox"/>	<input type="checkbox"/>	<input type="checkbox"/>	<input type="checkbox"/>	<input type="checkbox"/>	<input type="checkbox"/>	<input type="checkbox"/>	<input type="checkbox"/>	<input type="checkbox"/>	3101249
		<input type="checkbox"/>	<input type="checkbox"/>	<input type="checkbox"/>	<input type="checkbox"/>	<input type="checkbox"/>	<input type="checkbox"/>	<input type="checkbox"/>	<input type="checkbox"/>	<input type="checkbox"/>	<input type="checkbox"/>	<input type="checkbox"/>	<input type="checkbox"/>	3101213
		<input type="checkbox"/>	<input type="checkbox"/>	<input type="checkbox"/>	<input type="checkbox"/>	<input type="checkbox"/>	<input type="checkbox"/>	<input type="checkbox"/>	<input type="checkbox"/>	<input type="checkbox"/>	<input type="checkbox"/>	<input type="checkbox"/>	<input type="checkbox"/>	3101255
		<input type="checkbox"/>	<input type="checkbox"/>	<input type="checkbox"/>	<input type="checkbox"/>	<input type="checkbox"/>	<input type="checkbox"/>	<input type="checkbox"/>	<input type="checkbox"/>	<input type="checkbox"/>	<input type="checkbox"/>	<input type="checkbox"/>	<input type="checkbox"/>	3101259
		<input type="checkbox"/>	<input type="checkbox"/>	<input type="checkbox"/>	<input type="checkbox"/>	<input type="checkbox"/>	<input type="checkbox"/>	<input type="checkbox"/>	<input type="checkbox"/>	<input type="checkbox"/>	<input type="checkbox"/>	<input type="checkbox"/>	<input type="checkbox"/>	3101676
		<input type="checkbox"/>	<input type="checkbox"/>	<input type="checkbox"/>	<input type="checkbox"/>	<input type="checkbox"/>	<input type="checkbox"/>	<input type="checkbox"/>	<input type="checkbox"/>	<input type="checkbox"/>	<input type="checkbox"/>	<input type="checkbox"/>	<input type="checkbox"/>	3101233
<input type="checkbox"/>	<input type="checkbox"/>	<input type="checkbox"/>	<input type="checkbox"/>	<input type="checkbox"/>	<input type="checkbox"/>	<input type="checkbox"/>	<input type="checkbox"/>	<input type="checkbox"/>	<input type="checkbox"/>	<input type="checkbox"/>	<input type="checkbox"/>	3101230		
<input type="checkbox"/>	<input type="checkbox"/>	<input type="checkbox"/>	<input type="checkbox"/>	<input type="checkbox"/>	<input type="checkbox"/>	<input type="checkbox"/>	<input type="checkbox"/>	<input type="checkbox"/>	<input type="checkbox"/>	<input type="checkbox"/>	<input type="checkbox"/>	3101232		
<input type="checkbox"/>	<input type="checkbox"/>	<input type="checkbox"/>	<input type="checkbox"/>	<input type="checkbox"/>	<input type="checkbox"/>	<input type="checkbox"/>	<input type="checkbox"/>	<input type="checkbox"/>	<input type="checkbox"/>	<input type="checkbox"/>	<input type="checkbox"/>	3101234		
<input type="checkbox"/>	<input type="checkbox"/>	<input type="checkbox"/>	<input type="checkbox"/>	<input type="checkbox"/>	<input type="checkbox"/>	<input type="checkbox"/>	<input type="checkbox"/>	<input type="checkbox"/>	<input type="checkbox"/>	<input type="checkbox"/>	<input type="checkbox"/>	3101285		
<input type="checkbox"/>	<input type="checkbox"/>	<input type="checkbox"/>	<input type="checkbox"/>	<input type="checkbox"/>	<input type="checkbox"/>	<input type="checkbox"/>	<input type="checkbox"/>	<input type="checkbox"/>	<input type="checkbox"/>	<input type="checkbox"/>	<input type="checkbox"/>	3101282		
<input type="checkbox"/>	<input type="checkbox"/>	<input type="checkbox"/>	<input type="checkbox"/>	<input type="checkbox"/>	<input type="checkbox"/>	<input type="checkbox"/>	<input type="checkbox"/>	<input type="checkbox"/>	<input type="checkbox"/>	<input type="checkbox"/>	<input type="checkbox"/>	3101284		
<input type="checkbox"/>	<input type="checkbox"/>	<input type="checkbox"/>	<input type="checkbox"/>	<input type="checkbox"/>	<input type="checkbox"/>	<input type="checkbox"/>	<input type="checkbox"/>	<input type="checkbox"/>	<input type="checkbox"/>	<input type="checkbox"/>	<input type="checkbox"/>	3101283		
<input type="checkbox"/>	<input type="checkbox"/>	<input type="checkbox"/>	<input type="checkbox"/>	<input type="checkbox"/>	<input type="checkbox"/>	<input type="checkbox"/>	<input type="checkbox"/>	<input type="checkbox"/>	<input type="checkbox"/>	<input type="checkbox"/>	<input type="checkbox"/>	3101286		
<input type="checkbox"/>	<input type="checkbox"/>	<input type="checkbox"/>	<input type="checkbox"/>	<input type="checkbox"/>	<input type="checkbox"/>	<input type="checkbox"/>	<input type="checkbox"/>	<input type="checkbox"/>	<input type="checkbox"/>	<input type="checkbox"/>	<input type="checkbox"/>	3101313		
<input type="checkbox"/>	<input type="checkbox"/>	<input type="checkbox"/>	<input type="checkbox"/>	<input type="checkbox"/>	<input type="checkbox"/>	<input type="checkbox"/>	<input type="checkbox"/>	<input type="checkbox"/>	<input type="checkbox"/>	<input type="checkbox"/>	<input type="checkbox"/>	3101311		
<input type="checkbox"/>	<input type="checkbox"/>	<input type="checkbox"/>	<input type="checkbox"/>	<input type="checkbox"/>	<input type="checkbox"/>	<input type="checkbox"/>	<input type="checkbox"/>	<input type="checkbox"/>	<input type="checkbox"/>	<input type="checkbox"/>	<input type="checkbox"/>	3101668		
<input type="checkbox"/>	<input type="checkbox"/>	<input type="checkbox"/>	<input type="checkbox"/>	<input type="checkbox"/>	<input type="checkbox"/>	<input type="checkbox"/>	<input type="checkbox"/>	<input type="checkbox"/>	<input type="checkbox"/>	<input type="checkbox"/>	<input type="checkbox"/>	3101283		
<input type="checkbox"/>	<input type="checkbox"/>	<input type="checkbox"/>	<input type="checkbox"/>	<input type="checkbox"/>	<input type="checkbox"/>	<input type="checkbox"/>	<input type="checkbox"/>	<input type="checkbox"/>	<input type="checkbox"/>	<input type="checkbox"/>	<input type="checkbox"/>	3101286		
<input type="checkbox"/>	<input type="checkbox"/>	<input type="checkbox"/>	<input type="checkbox"/>	<input type="checkbox"/>	<input type="checkbox"/>	<input type="checkbox"/>	<input type="checkbox"/>	<input type="checkbox"/>	<input type="checkbox"/>	<input type="checkbox"/>	<input type="checkbox"/>	3101668		

3M™ DBI-SALA® Nano-Lok™

Extended Length Self-Retracting Lifelines

	Nano-Lok™ Extended Length SRL	Length	Canada Part #
Single-leg	Nano-Lok™ Extended Length, with snap hook and quick connector for harness mounting	10' (3 m)	3101598
	Nano-Lok™ Extended Length, with snap hook and swiveling anchor loop with carabiner	10' (3 m)	3101599
	Nano-Lok™ Extended Length, with aluminum carabiner and swiveling anchor loop with aluminum carabiner	10' (3 m)	3101600
	Nano-Lok™ Extended Length, with aluminum comfort grip rebar hook and quick connector for harness mounting	9' (2.7 m)	3101678
	Nano-Lok™ Extended Length Self Retracting Lifeline, galvanized steel cable, swivel hook	15' (4.5 m)	3501696
	Nano-Lok™ Extended Length Self Retracting Lifeline, stainless steel cable, swivel hook	15' (4.5 m)	3501697
	Nano-Lok™ Extended Length Self Retracting Lifeline, Dyneema® Fibre, snap hook	20' (6 m)	3101874
	Nano-Lok™ Extended Length Self Retracting Lifeline, Dyneema® Fibre, swivel hook	20' (6 m)	3103875
	Nano-Lok™ Extended Length Self Retracting Lifeline, Dyneema® Fibre, swivel hook	20' (6 m)	3101876
Twin-leg	Nano-Lok™ Extended Length, with snap hook and quick connector for harness mounting	10' (3 m)	3101628
	Nano-Lok™ Extended Length, with and steel rebar hooks, quick connector for harness mounting	9' (2.7 m)	3101634

Self-Retracting Lifelines

3M™ DBI-SALA® Nano-Lok™



Arc Flash Self-Retracting Lifelines

	Lifeline hook								Anchorage type				Canada Part #	
	Steel Snap Hook	Steel Swiveling Snap Hook	Steel Rebar Hook	Steel Rebar Look Hook	Aluminum Captive Carabiner	Aluminum Rebar Hook	Aluminum Rebar Lock Hook	Dielectric Web Loop	11' Tie-Back	Single-Leg Interface	Twin-Leg Interface	Steel Carabiner		Web Leg w/ Alum. Snap Hook
8' Single-leg	■													3101541
		■												3101542
			■											3101543
				■										3101544
					■									3101545
						■								3101546
							■							3101547
8' Twin-leg	■											■		3101548
		■												3101549
			■											3101550
				■										3101551
					■									3101552
						■								3101553
							■							3101554
							■						3101555	
								■					3101579	

Designed specifically for utility applications.

- 8' (2.4 m) working length.
- With Nomex®/Kevlar® fibre web lifeline and reinforced edges for superior wear resistance and durability.
- Features an arc flash industry logo to easily identify the product application.
- Arc flash compliant, tested to 40 cal/cm². Meets ASTM F887.
- Meets or exceeds industry standards.



3M™ DBI-SALA® Nano-Lok™

for Hot Work Use Self-Retracting Lifelines



	Lifeline hook								Anchorage type				Canada Part #
	Steel Snap Hook	Steel Swiveling Snap Hook	Steel Rebar Hook	Steel Rebar Look Hook	Aluminum Captive Carabiner	Aluminum Rebar Hook	Comfort Grip Rebar Hook	Aluminum Rebar Lock Hook	9' Tie-Back	Single-Leg Interface	Twin-Leg Interface	Steel Carabiner	
6' Single-leg	■												3101506
		■											3101507
			■										3101508
				■									3101509
					■								3101510
						■							3101511
							■						3101677
6' Twin-leg	■											■	3101512
		■											3101513
			■										3101514
				■									3101516
					■								3101517
						■							3101518
							■						3101519
							■					3101520	

This unique SRL was tested to 8 calories, ensuring durability in applications like welding, grinding and torching.

It is reinforced with Kevlar® fibre to withstand sparks, weld splatter and other high heat exposure.

- 6' (1.8 m) working length
- Universal hot work icon to quickly and easily identify hot work products.
- Equipped with RFID.
- Meets or exceeds industry standards.



3M™ DBI-SALA® Nano-Lok™ edge

Self-Retracting Lifeline

The Nano-Lok™ edge SRL is specifically designed for foot level tie-off and sharp edge applications. It uses an innovative combination of lifeline material, energy absorption, and its harness connection to reduce forces on both the wearer and the edge. This technology allows Nano-Lok™ edge to meet the most stringent safety standards. It's available in single and twin-leg units, and it's orange so you'll know it's the right gear for the job.

1 Easy-to-install connector

Providing 360 degrees of rotation, the direct-to-harness connection provides seamless integration of the energy absorber and leaves the D-ring open for rescue or other equipment.

2 Impact-resistant housing

Lightweight thermoplastic housing provides maximum durability.

3 Global sharp edge icon

Our universal icon makes identification of sharp edge product quick and easy.

4 Tough and flexible galvanized cable lifeline

The 8' (2.4 m) of 3/16" (5 mm) cable provides maximum range of motion, durability, and cut resistance.

5 Integrated, backpack-style energy absorber

The energy absorber and connector work together to limit forces on both the worker and the impacted edge. Backpack design stays tight to the harness and evenly disperses the unit's weight.



Model shown
3500232

Self-Retracting Lifelines

3M™ DBI-SALA® Nano-Lok™ edge Self-Retracting Lifelines

In your line of work, anchoring at your feet may be the only option. Traditional equipment is not designed for this application, and slack could literally trip you up. The Nano-Lok™ edge SRL is specifically designed for foot level tie-off, virtually eliminating that hazard. Not only that, but this lifeline is designed with sharp edges in mind and takes the guesswork out of your work. The technology speaks for itself.

You can find more detailed information on how the Nano-Lok™ edge SRL keeps you safe on our website. Visit 3M.ca/FallProtection



Model shown
3500216

Product selection guide

									SRL	
									Canada Part #	
Single-leg										3500259
										3500219
										3500251
										3500252
										3500217
										3500218
										3500221
										3500222
										3500260
										3500288
Twin-leg										3500234
										3500250
										3500253
										3500232
										3500233
										3500236
										3500237
										3500237

*All versions are 8' (2.4 m) in length.

3M™ DBI-SALA® Sealed-Blok

Self-Retracting Lifelines

Grease, dirt and moisture are just part of your job. Keeping them from affecting the performance of your SRL is ours. These sealed SRLs are constructed from heavy-duty, corrosion-resistant materials, and incorporate a patented concept that separates all dynamic components—including the motor spring and brake—from foreign elements.

- **Anti-ratcheting design.**
Stays locked on rigid and non-rigid (horizontal lifeline) anchors.
- **420 lb (190.5 kg) weight capacity (All non-RSQ models).**
Higher capacity for operator and tools (option).
- **Sealed design Meets IP68 and IP69K rating.**

1 Carrying handle

Built-in design for easy transport—certified as secondary fall arrest rated anchorage point.

2 Galvanized and stainless steel cable

Abrasion resistant and corrosion-resistant lifeline options.

3 Self-locking swivel hook

- Limits lifeline twisting
- Integrated impact indicator
- 3,600 lb (16 kN) gate reduces accidental disengagements (“roll-out”)

4 Fast-Line™ Cable Lifeline Replacement System

Provides the user with ability to replace the lifeline in the field.

5 Pivoting anchorage loop

Centers the load.

6 Aluminum housing

Provides exceptional strength durability and corrosion resistance.

7 Cast aluminum cover



3400902C
Model shown

Product selection guide

		Lifeline material	Hook material	Includes mounting bracket	Retrieval capability	RSQ capacity	310 lb (141 kg) weight capacity	420 lb (189 kg) weight capacity	15' (4.5 m)	30' (9.1 m)	50' (15.2 m)	85' (25.6 m)	130' (39.6 m)	175' (53.3 m)		
CSA	Galvanized cable	Steel						■	3400825C	3400800C						
								■		3400850C		3400900C	3400863	3400968	3400653	
						■						3400920C	3400875	3400980	3400663	
							■					3400940C	3400913			
								■				3400930C	3400887			
						■						3400853C				
	Stainless steel cable	Stainless steel								3400827C	3400802C					
												3400923C	3400876	3400981		
												3400902C	3400865	3400970	3400655	
												3400932C	3400889			
												3400852C				
												3400922C	3400879	3400984	3400661	
									3400942C	3400915						
									3400858C							
										3400942C	3400883	3400988				
Weight									12 lb (5.5 kg)	18 lb (8 kg)	29 lb (13 kg)	44 lb (20 kg)	60 lb (27 kg)	114 lb (51.7 kg)		
Sealed design									Sealed	Sealed	Sealed	Sealed	Sealed	Sealed		
Fast-Line											Standard	Standard	Standard	Standard		
Approximate length									10.2" (25 cm)	11.5" (29 cm)	13.3" (34 cm)	16" (41 cm)	18.7" (48 cm)	16.8" (42.7 cm)		
Approximate width									7.6" (19 cm)	9.4" (24 cm)	10.4" (27 cm)	9.9" (25 cm)	11.7" (30 cm)	14" (35.6 cm)		
Approximate height									4.3" (11 cm)	5.4" (14 cm)	6.9" (18 cm)	6.7" (17 cm)	7.2" (18 cm)	12.3" (31.2 cm)		



Fast-Line™ Cable Lifeline Replacement System allows the lifeline assembly to be replaced out in the field.

Other models available; please contact us.

3M™ DBI-SALA® Fast-Line™

Cable Replacement Assemblies



Galvanized Cable with Plated Hook

Fast-Line™ Galvanized Replacement Cable Assembly

Part #	Length
3900105	50' (15 m)
3900108	85' (25.5 m)
3900112	130' (39 m)

Stainless Steel Cable with Stainless Steel Hook

Fast-Line™ Galvanized Replacement Cable Assembly

Part #	Length
3900107	50' (15 m)
3900111	85' (25.5 m)
3900114	130' (39 m)

3M™ DBI-SALA® Ultra-Lok

Self-Retracting Lifelines

Like our Sealed-Blok, the Ultra-Lok Lifeline also extends and retracts, so you can move about freely at normal speeds within a recommended working area. Should a fall occur, a speed-sensing brake system (1.3 m/sec.) will activate, stopping the fall and reducing the imposed forces to 900 lb (4 kN) or less.

Lifeline material	Hook style	Hook throat size (in.)	Rated gate capacity (lb)	Swivel hook	Leading edge	RSQ	SRL weight capacity (lb)	15' (4.6 m)	20' (6.1 m)	30' (9.1 m)	55' (16.7 m)	85' (26 m)
Galvanized cable	Steel carabiner	5/8	3,600	■			310		3504445C	3504446C		
	Steel hook	5/8	3,600	■	■		310	3504422C		3504500C	3504600C	
Stainless steel cable		Steel hook	3/4	3,600	■		■	310		3504433C	3504430C	
	3/4		3,600	■		■	310		3504434C	3504431C		
	Stainless steel hook	3/4	3,600	■		■	310		3504437C	3504432C		
		3/4	3,600	■			310		3504438C			
Vectran rope	Steel hook	3/4	3,600	■			310		3504438C			
Approximate web SRL weight								-	5.5 lb (2.5 kg)	-	-	-
Approximate cable (galv) SRL weight								11 lb (5 kg)	9 lb (4.1 kg)	11 lb (5 kg)	30 lb (13.6 kg)	33 lb (15 kg)

Our Nylon web Ultra-Loks™ have been replaced by the Nano-Lok™ Extended Length SRLs - see page 41.

Our 50' and 85' SS Ultra-Loks™ have been replaced by the Smart Lock SRL - see page 46.

3M™ DBI-SALA®

Smart Lock Self-Retracting Lifelines

Our smartest SRLs yet. From reducing nuisance lockups, to simplifying inspections, every detail of the new 3M™ DBI-SALA® Smart Lock Self-Retracting Lifelines is designed to help increase your productivity, safety and convenience.

Vertical (Non-Leading Edge)

Part #	Cable	Colour	Length
3503800	Galvanized Cable	Blue	30'
3503801	Stainless Steel Cable	Blue	30'
3503803	Galvanized Cable	Blue	20'
3503804	Stainless Steel Cable	Blue	20'
3503820	Rope	Blue	35'
3503821	Stainless Steel Cable	Blue	35'
3503823	Stainless Steel Cable	Blue	50'
3503824	Galvanized Cable	Blue	50'

Vertical (Arc Flash)

Part #	Cable	Colour	Length
3503805	Technora® polyester rope with Kevlar sheath	Blue	20'

Horizontal (Leading Edge)

Part #	Cable	Colour	Length
3503802	Galvanized Cable	Blue	20'
3503822	Galvanized Cable	Blue	30'





Anchorage connectors

Anchorage Connectors



Your gear is only as good as the safety anchor it is connected to. This is why 3M helps workers do their jobs with confidence by manufacturing anchorage connectors that have been rigorously tested to meet or exceed industry standards.

We offer a complete line of anchorage connectors so that you can work with the total peace of mind that you've got the best gear available for the job. Each of our anchor systems are specifically manufactured to meet your unique applications.

The type of anchor you need depends on the type of work being done. Anchorages are sold by what they connect to (general/all-purpose, steel, concrete, roof, mining or specialty), whether they are fixed or mobile, or whether they are permanent or portable. Each anchor must provide a secure point of attachment whether the application is steel, concrete or roof-based and be capable of supporting your fall protection system loads.



Anchorage Connectors

3M™ DBI-SALA®

General Anchorage Connectors

Extremely versatile anchors are simply choked-off to the anchorage structure, to provide a fast and safe 5,000 lb. (22 kN) tie-off point for your personal fall protection system.



Description	Part #
3M™ DBI-SALA® Web Tie-Off Adaptor, 3 ft (0.9 m), pass-through design and abrasion resistant polyester wear pad.	1003000C
3M™ DBI-SALA® Web Tie-Off Adaptor, 6 ft (1.8 m), pass-through design and abrasion resistant polyester wear pad	1003006C
3M™ DBI-SALA® Web Tie-Off Adapter: pass-through type x 10' (3 m)	1002010
3M™ DBI-SALA® Web Tie-Off Adaptor, 6 ft (1.8 m) adjustable pass-through type	1002106

3M™ DBI-SALA®

Tie-Off Adapter for Hot Work Use

Reinforced with Kevlar® fibre webbing; ideal for high heat environments, pass-through type with 1-3/4" (4.4 cm) polyester strength member x 6' (1.8 m).



Description	Part #
3M™ DBI-SALA® Web Tie-Off Adapter for Hot Work Use: with Kevlar® fibre, pass-through type x 3' (0.9 m)	1002200
3M™ DBI-SALA® Web Tie-Off Adapter: with Kevlar® fibre, pass-through type x 4' (1.2 m)	1002201

3M™ DBI-SALA®

Web Scaffold Choker

Choker style attaches to 3" (7.6 cm) diameter anchorage. 1" (2.5 cm) polyester strength member x 17" (43 cm).



Description	Part #
3M™ DBI-SALA® Web Scaffold Choker, 1.4 ft (0.4 m)	1201390
3M™ DBI-SALA® Web Scaffold Choker, 2 ft (0.6 m)	1201391
3M™ DBI-SALA® Web Scaffold Choker with coated hardware and coated web, 4 ft (1.2 m)	1201421

3M™ DBI-SALA®

Cable Tie-Off Adapter: Flemished Eye

Pass-through design. 7 in. x 19-3/8 in. (9.5 mm) stainless steel cable with O-rings x 4 ft. (1.2 m).



Description	Part #
3M™ DBI-SALA® Cable Tie-Off Adapter, pass-through type x 4 ft (1.21)	5900550C
3M™ DBI-SALA® Cable Tie-Off Adapter, pass-through type x 6 ft (1.8 m)	5900551C
3M™ DBI-SALA® Cable Tie-Off Adapter, pass-through type x 10 ft (3.0m)	5900552C
3M™ DBI-SALA® Cable Tie-Off Adapter, pass-through type x 8 ft (2.44)	5900553C
3M™ DBI-SALA® Cable Tie-Off Adapter, pass-through type x 12 ft (3.66)	5900554C
3M™ DBI-SALA® Cable Tie-Off Adapter, pass-through type x 27 ft (8.22)	5900555C
3M™ DBI-SALA® Cable Tie-Off Adapter, pass-through type x 23 ft (7.01)	5900556C
3M™ DBI-SALA® Cable Tie-Off Adapter, pass-through type x 24 ft (7.31)	5900557C
3M™ DBI-SALA® Cable Tie-Off Adapter, pass-through type x 7 ft (2.13)	5900558C
3M™ DBI-SALA® Cable Tie-Off Adapter, pass-through type x 50 ft (15.24)	5900559C

3M™ DBI-SALA®

Steel Anchorage Connectors

Extremely versatile anchors for steel that are lightweight and compact, providing an easy to install and safe 5,000 lb. (22 kN) tie-off point for your personal fall protection system.



2100159

3M™ DBI-SALA®

Fixed Beam Anchor

It installs in seconds to the beam structure in any orientation, with final tightening using a built-in adjustment handle. Ideal as a single-person anchor point or as end-anchors for a Sayflin Horizontal Lifeline System. Fits up to 1-½" (3.8 cm) thick beam flange, 2-½"-12" (6.3 cm-30.5 cm) wide.



Description	Fits beam flanges up to	Part #
3M™ DBI-SALA® Fixed Beam Anchor	1-½" (3.8 cm) thick x 2-½" - 18" (6.3 cm-45.7 cm) wide	2108407
3M™ DBI-SALA® Fixed Beam Anchor	1-½" (3.8 cm) thick x 2-½" - 24" (6.3 cm - 61 cm) wide	2108408
3M™ DBI-SALA® Fixed Beam Anchor	½" - 2-½" (1.3 cm - 6.3 cm) thick x 12" - 36" (30.5 cm - 91.4 cm)	2108410

3M™ DBI-SALA®

Sliding Beam Anchor

It installs in seconds to the beam structure in any orientation, with final tightening using a built-in adjustment handle. Ideal as a single-person anchor point or as end-anchors for a Sayflin Horizontal Lifeline System. Fits up to 1-½" (3.8 cm) thick beam flange, 2-½" - 12" (6.3 cm - 30.5 cm) wide. 360 - degree swiveling D-ring optimizes your mobility on the beam.



- Corrosion resistant construction meets ANSI standards for weather, environmental and storage conditions.
- Dual ratcheting adjustment buttons are accessible above the beam, while locking mechanism is located on the side to reduce accidental engagement.
- Compact size and lightweight materials.
- Snap-in design of wear pads allows them to be replaced quickly in the field.

Description	Beam size	Part #
3M™ DBI-SALA® Sliding Beam Anchor, small	3.5 in to 14 in (9 cm to 35.5 cm)	2104710
3M™ DBI-SALA® Sliding Beam Anchor, large	12 in to 30 in (30.5 cm to 76.2 cm)	2104715
3M™ DBI-SALA® Sliding Beam Anchor Replacement Wear Pads, 2 each	Small – fits with 2104710	2110815
3M™ DBI-SALA® Sliding Beam Anchor Replacement Wear Pads, 2 each	Large – fits with 2104715	2110816

Anchorage Connectors



2103143C

3M™ DBI-SALA®



Trolley for I-Beam

The trolley is for use with self-retracting lifelines on horizontal beams and has been engineered for ease-of-use and superior performance. It glides effortlessly along the beam and provides horizontal mobility.

- Attachable anywhere along beam, including midpoint.
- Non-corrosive double-shielded wheel bearings are maintenance-free.
- Trolley guards protect the wheels from damage and keep beam clear of debris.
- Fits 3" - 8" (7.6 cm - 20.3 cm) flange width and thickness up to 1/16" (1.7 cm)

3M™ DBI-SALA®

Steel Anchorage Connectors

Description	Metal	Image	Part #
3M™ DBI-SALA® Steel Plate Anchor: This plate anchor offers a compact, reliable attachment to 3/8" - 1" (0.9 cm - 1.2 cm) thick plate steel for connecting your lanyard, vertical lifeline system or self-retracting lifeline. Easy to use set-screw design ensures positive and safe connection. Complete with integral D-ring tie-off point. Durable, corrosion-resistant zinc-plated steel construction.	Zinc-Plated		2104550
3M™ DBI-SALA® Tandem Pulley: For 3/8" - 1/2" (0.9 cm - 1.2 cm) rope or cable.	-		8800023
3M™ DBI-SALA® D-Ring Anchorage Plate: The D-Ring Anchorage Plate can be bolted or welded to a structure, offering a compact, reliable connection point for your fall protection system. Two 1/2" (1.2 cm) diameter attachment holes. Cadmium-plated steel D-ring. Raw steel anchorage plate. Plate size: 1/4" x 2" x 4 - 1/2" (0.6 cm x 5 cm x 11.4 cm)	Cadmium-plated		2101634
3M™ DBI-SALA® D-Ring Anchorage Plate: The D-Ring Anchorage Plate can be bolted or welded to a structure, offering a compact, reliable connection point for your fall protection system. Two 1/2" (1.2 cm) diameter attachment holes. 304 stainless steel D-ring. Raw steel anchorage plate. Plate size: 1/4" x 2" x 4 - 1/2" (0.6 cm x 5 cm x 11.4 cm)	304 Stainless Steel		2101636
3M™ DBI-SALA® D-Ring Anchorage Plate: The D-Ring Anchorage Plate can be bolted or welded to a structure, offering a compact, reliable connection point for your fall protection system. Two 1/2" (1.2 cm) diameter attachment holes. 316 stainless steel D-ring. Raw steel anchorage plate. Plate size: 1/4" x 2" x 4 - 1/2" (0.6 cm x 5 cm x 11.4 cm)	316 Stainless Steel		2101638
D-ring Anchorage Plate, with stainless steel plate, silver, yellow zinc, 0.25 in x 2 in x 4.5 in (6 mm x 51 mm x 114 mm)	304 Stainless Steel		2101639

3M™ DBI-SALA®

Concrete Anchorage Connectors

Extremely versatile anchors for concrete that are lightweight and compact, providing an easy-to-install and safe 5,000 lb. (22 kN) tie-off point for your personal fall protection system.



2104568

3M™ DBI-SALA®

Concrete D-Ring Anchor

A simple, versatile and safe concrete anchor solution for use in temporary or permanent applications, providing a safe tie-off point.

- Reusable D-ring assembly.
- Rugged design for harsh environments.
- Safe “hook-up” indicator notifies user of proper installation.
- Install into 1/8", 18 mm or 3/4" holes—only standard drill bits needed.



Description	Part #
3M™ DBI-SALA® Concrete D-Ring Anchor with 5 additional bolts	2104561
3M™ DBI-SALA® Concrete D-Ring Anchor with 11 additional bolts	2104562
3M™ DBI-SALA® 10-pack of Replacement Bolts for Concrete D-Ring Anchor	2100066

2101004C

3M™ DBI-SALA®

Concrete Detent Anchor

A versatile, simple and safe concrete anchor utilizing pre-installed sockets, enabling the user to connect and disconnect from the anchorage by simply pressing a button.

- Use for floor, wall or ceiling type applications.
- Provides convenient tie-off points wherever needed.
- Push-button operation for fast and easy operation.
- Socket includes cover cap to hide recess, blending into the decor.

Description	Part #
3M™ DBI-SALA® Concrete Detent Socket and cap only	2101000C
3M™ DBI-SALA® Concrete Detent Pin only	2101002C
3M™ DBI-SALA® Concrete Pour-in-Place Anchor	2100152
3M™ DBI-SALA® Pour-in-Place Detent Anchor Assembly with detent pin and socket	2100169



Anchorage Connectors

2104816

3M™ DBI-SALA®

Drop-Through Anchor

10' (3.0 m) drop-through anchor with swiveling D-ring for concrete and steel, fits 1-1/2" to 1-3/4" dia. hole (38.1 to 44.5 mm) with a minimum thickness of 4" (101.6 mm).



Description	Part #
3M™ DBI-SALA® Drop-Through Anchor x 2' (0.6 m)	2104819
3M™ DBI-SALA® Drop-Through Anchor x 6' (1.8 m)	2104818
3M™ DBI-SALA® Drop-Through Anchor x 8.5' (2.6 m)	2104817



2190074

3M™ DBI-SALA® Construction Roof Anchor

This anchor provides workers with a quick, easy and safe anchorage point during pre-cast concrete work.

- For use with horizontal Smart Lock SRL (leading edge).
- Swivels 360 degrees offering complete freedom of movement.
- Also use as end anchors for a temporary horizontal lifeline.
- Built-in ratchet securing system—no special tools required.

8523178

3M™ DBI-SALA®

Concrete Parapet Anchor

Portable and reusable concrete anchor installs quickly and easily using standard concrete tools, providing a fast and safe tie-off point.

- Exclusive quick-release button for fast removal.
- Unique forged connection ring provides a compatible tie-off point.
- Shielded load cable and chock release cables.
- Exclusive pivoting easy-grip handle.



2100050

Concrete Anchor Strap

Our disposable concrete anchor strap provides a temporary anchorage on concrete forms and is extremely easy to install and use.

- Loop slips over rebar, then concrete is poured over. When no longer needed, simply cut strap and discard.
- Durable 1-3/4 in. polyester construction x 3-1/2 ft. (1 m). Full length wear pad for abrasion resistance.
- D-ring provides compatible tie-off point.



Description	Part #
Concrete Anchor Strap with D-ring, 48 in. (1.2 m)	2100053
Concrete Anchor Strap, no D-ring, 3-1/2 ft. (1 m)	2100061

Anchorage Connectors

1231305C

3M™ DBI-SALA® Saflok™

Max Web Anchor

Anchor can be directly connected to many concrete wall forms to provide a tie-off point for your system. Web anchor strap with large opening, Saflok™ Max Hook at one end, D-ring at other x 1.5' (45 cm)



2103673

3M™ DBI-SALA®

Portable Reusable Roof Anchor

For use on flat or sloped wood roofs. Installs with twelve 16D nails or six ¼" x 2-½" bolts. Can be used with horizontal lifeline systems for added versatility.



2103677

3M™ DBI-SALA®

Portable Reusable Roof Anchor

For use on flat or sloped wood roofs. Installs with three grade 5, 5/16" x 3" lag screws. Compact design is extremely easy to transport, install, dismantle and store.



2104541

3M™ DBI-SALA®

Permanent Roof Anchor with Detachable D-Ring

Removable D-ring assembly allows you to leave behind the clamp assembly and then shingle over it, reusing the D-ring at another location. Fits 2" x 6' to 2" x 8' roof truss, joist or rafter.



Description	Fits	Part #
3M™ DBI-SALA® Permanent Roof Anchor with Detachable D-Ring	2" x 10' to 2" x 12'	2104542
3M™ DBI-SALA® Permanent Roof Anchor with Detachable D-Ring	2" x 4'	2104540

2103670

3M™ DBI-SALA®

Permanent Roof Anchor with flashing and cap

Clamps onto roof truss up to 2" x 8' size and comes complete with flashing to prevent leakage and D-ring cap for aesthetics. Provides fall protection during initial construction as well as for future homeowner.



Description	Part #
3M™ DBI-SALA® Permanent Roof Anchor with flashing and cap, fits 2" x 10' to 2" x 12'	2103671

2190073

3M™ DBI-SALA®

Portable/Reusable Standing Seam Roof Anchor

Attaches to sloped or flat structural standing seam roofs. Telescoping adjustment fits 12", 24", 30", 32" and 36" seam spacing. Swivels 360 degrees and designed for use with the Smart Lock SRL (Order SRL separately).



2100185

3M™ DBI-SALA®

Freestanding Counterweight Anchor

Freestanding system is easily placed on top of the roof surface to provide a tie-off point for one worker. A swiveling D-ring integrated into the assembly allows the worker to move freely 360 degrees. Lifting kit also available.



Description	Part #
3M™ DBI-SALA® Freestanding Counterweight Anchor 45 lb. (20 kg) Single Replacement Counterweight	7200439

Anchorage Connectors

2100133

3M™ DBI-SALA®

Roof Top Anchor with extra large baseplate for metal, concrete and wood

All assembled kits include an extra large baseplate and an integrated anchorage point for one user fall arrest. Permanent anchor assembly is designed for 26 gauge or thicker corrugated metal decking with ribs 10" (254 mm) to 20" (508 mm) apart, 5/8" (16 mm) CDX plywood or concrete. Minimum concrete compressive strength of 3,000 PSI (21 MPa). Minimum thickness of 6-1/2" (16.5 cm) for chemical anchors. Minimum thickness of 5-1/2" (14 cm) for mechanical anchors.



2100138

3M™ DBI-SALA®

Standing Seam Roof Anchor

Kit includes a baseplate and an integrated anchorage point for one user fall arrest. Permanent anchor assembly designed specifically for standing seam roofs.



Description	Part #
3M™ DBI-SALA® Standing Seam Roof Anchor "Z" Maxi Clamp Kit, 4-pack, for bulb-type standing seams	7241204
3M™ DBI-SALA® Standing Seam Roof Anchor "E" Maxi Clamp Kit, 4-pack, for double fold standing seams	7241206
3M™ DBI-SALA® Standing Seam Roof Anchor "U" Maxi Clamp Kit, 4-pack, for single fold standing seams	7241208



2190071

3M™ DBI-SALA®

Reusable Swiveling Roof Anchor

Provides 360 degrees of mobility and protection on sloped or flat wood and metal decking. For use with Smart Lock SRLs (order separately). May also be used as end-anchors for horizontal lifeline system.



2103690

3M™ DBI-SALA®

3-Man Reusable Swiveling Roof Anchor

- Installs to sloped wood roof structures.
- Fast and easy screw installation; Fastener kit included.
- Three built-in swiveling D-ring anchor points.
- Durable and corrosion resistant construction.
- Compact and lightweight design.
- Adjustable feet and legs.
- 54" (137.2 cm) height when full extended.
- Portable and reusable.



2100090

3M™ DBI-SALA®

Perimeter Limiter Leading Edge Anchor

- Large foam filled trailer tires won't go flat and provide easy movement.
- Rotating 7-½' (2.3 m) mast and anchorage arm for added freedom of movement.
- Pre-drilled holes for accessory rescue winches or job site boxes.
- Additional weights and taller mast can be added for job site flexibility.



2100080

3M™ DBI-SALA®

Door/Window Jamb Anchor

Non-penetrating anchor is lightweight and portable, requiring no tools for attachment. Adjustable opening ranging from 21.5" - 51.5" (54.6 cm - 130.8 cm). Rated for 3,600 lb. (16 kN)



3M™ DBI-SALA® Mobi-Lok™ Self-Contained Vacuum Anchor System

- 1 Audio alarm warning system**
- 2 Convenient carrying handle**
- 3 Secure anchor point**
- 4 Aviation rated electronics**
Intrinsically safe
- 5 Vacuum level indicator**
- 6 Shop air quick connect**
- 7 Surface friendly**
Skydrol-resistant, EPDM rubber seal (Aviation model)
- 8 Fits small fuselage**
Pad conforms to fuselage as small as 6" (1.8 m) in diameter
- 9 Optional cylinder attachment**
Increases portability



Horizontal lifeline-ready

Two Mobi-Lok™ units can be connected using a horizontal lifeline (HLL) to create a continuous anchor point for up to two people.

Product specifications

	Shop air powered	Shop air/gas powered
Main support assembly	Anodized aluminum	
Vacuum seal pad material - aviation	EPDM	
Vacuum seal pad material - general industry	Polybutadiene	
Electronics	4 AA lithium batteries	
Shop air requirements	80 psi - 150 psi	
Compressed gas bottle requirements	—	3,000 psi, 48 in ³
Dimensions	22" x 22" x 6" (55 cm x 55 cm x 15 cm)	
System weight	17.4 lb. (7.8 kg)	19.9 lb. (9.0 kg)
Capacity	310 lb. (140 kg); One person	
Surface temperature range	-29°C to 60°C (-20°F to 140°F)	
Vacuum anchor static capacity	3,375 lb. (15 kN)	

Product selection guide

Components	Aviation	General industry
Mobi-Lok™ SCVA assembly (shop air powered)	2200107	2200094
Mobi-Lok™ SCVA assembly with on board bottle attachment (shop air or gas powered)	2200108	2200095
Secondary pad assembly (optional)	2200109	—
Secondary pad hose (optional) – 50' (15 m)	2200130	
Aviation HLL kit (includes secondary pad, 40' HLL, and secondary pad 50' hose)	2200123	—
80' (24 m) 2-person HLL system	—	—
Aviation Kit (includes Mobi-Lok™ SCVA assembly and bottle)	2200122	—
Replacement compressed air cylinder	2200085	
Carry case included		

System selection guide

	Aviation	General industry
Standard unit for fall arrest/restraint	2200108 or 2200107	2200095 or 2200094
40' (12 m) HLL system	2200108+2200123 or 2200107+2200123	2200095 or 2200094
80' (24 m) HLL system	2200108*2+2200109+2200130 or 2200107*2+2200109+2200130	2200095*2+2200130 or 2200094*2+2200130

Anchorage Connectors

2104527

3M™ DBI-SALA®

Remote Anchoring System

Provides a safe means to anchor a fall protection device to an overhead location beyond normal reach.

- Pole adjusts from 6 ft.-12 ft. (1.8 m-3.6 m)
- Tie-off adapter tool for installation of anchorage device.
- Hook attachment tool for installation of 3,600 lb. gated snap hooks.
- Tie-off adapter x 3 ft. (0.9 m) and carrying bag.



Description	Part #
System with 8 ft.-16 ft. (2.4 m-4.8 m) adjustable pole	2104528
Snap Hook Connector Tool for 3,600 lb. gated hooks.	2104529
System, 6 ft.-12 ft. (1.8 m-3.6 m) adjustable pole with original and 3,600 lb. gated hook tools.	2104530
System, 8 ft.-16 ft. (2.4 m-4.8 m) adjustable pole with original and 3,600 lb. gated hook tools.	2104531

2104803

3M™ DBI-SALA® Saflok™

Wood Pole and Steel Structure Anchor Systems

Provides wood pole climber with 100% fall protection, allowing installation of anchor and lifeline to top of pole from the ground. Quickly and safely climb prior to connecting work positioning system.

- Compatible with most hot stick poles.
- Includes anchor tube with installation/removal tool.
- 80 ft. (24 m), 5/8 in. (16 mm) dielectric rope and two carabiners.
- Rope grab with energy-absorbing lanyard.
- Chain tensioner, web loop and carrying bag.



Description	Part #
Saflok™ Steel Structure Fall Arrest System with anchor tube, installation/removal tool, 80 ft. (24 m), 5/8 in. (16 mm) high dielectric rope, carabiner, rope grab with energy-absorbing lanyard, rescue loop sling and carrying bag	2104811
Saflok™ Pole Anchor System with anchor tube, 80 ft. (24 m), 5/8 in. (16 mm) high dielectric rope, installation/removal tool, one carabiner, rope grab with integrated energy-absorbing lanyard and carrying bag	2104802

Anchorage Connectors

3M™ DBI-SALA® Fixed Ladder SRL Anchors

Ideal fall protection solution for step-through style fixed ladder systems.

- Easy to transport: under 30 lb. for ease of transport and installation
- Simple setup: installs on the ladder in 5 minutes or less
- Versatile installation: the ladder anchor can be mounted to the front or behind the ladder with left, right or centre alignments
- Compatible with your existing fall protection harness: unlike a fixed cable system, this solution doesn't require a front D-ring, which can help reduce overall implementation costs
- Designed for durability: available in galvanized or stainless steel
- Meets 29 CFR OSHA 1910 Walking Working Surfaces Section 1910.27.

Description	Length	Material	Part #
3M™ DBI-SALA® Fixed Ladder SRL Anchor	4 ft	Galvanized	6100562
3M™ DBI-SALA® Fixed Ladder SRL Anchor	4 ft	Stainless Steel	6100563
3M™ DBI-SALA® Fixed Ladder SRL Anchor	6 ft	Galvanized	6100564
3M™ DBI-SALA® Fixed Ladder SRL Anchor	6 ft	Stainless Steel	6100565
3M™ DBI-SALA® Ladder Anchor Tagline			6100566

Create a complete system with a
3M™ DBI-SALA® Self-Retracting Lifeline.

Our Sealed-Blok design includes environmentally sealed dynamic components making it a durable solution.





Confined Space Rescue

Confined Space Rescue

Helping you breathe easy, even in tight spaces. That's the confidence and peace-of-mind that comes from having a customized and reliable confined space rescue system at hand. Our extensive line of high-quality, rugged systems are trusted by safety engineers and site directors alike – helping rescue workers in confined spaces quickly and flawlessly. Meeting applicable industry standards, each confined space rescue system and compliance.



What to look for in a confined space rescue system:

Ease-of-use

Your systems must provide you with the ability to handle a crisis simply, flawlessly and immediately. During an emergency, time is of the essence.

Mechanical systems

Lifeline type and length are just a few of the options you may need to consider. In some situations, a back-up system may be required.

Durability

All system components must be made from quality materials strong enough to endure rough handling and exposure to the elements.

Versatility

Your system should be adjustable and adaptable to extreme environments and uneven terrain. A modular design is also helpful, allowing you to add to the system over time.

Strength

Your system must be rated for your application, such as fall arrest, rescue, man-riding or material handling. Choose one that maximizes strength and minimizes weight.

Portability

Your system should be lightweight and easy to transport, set up and store.

3M™ DBI-SALA®

Davit Arm System Components

Variable offset davits are designed for use where multiple offset masts are required. The variable offset masts may be equipped with front mounted and/or back mounted winches or Self-Retracting Lifelines (SRLs) and feature an anchor point rated up to 5,000 lb (22 kN), depending on pin position. For applications with overhead clearance restrictions, the adjustable height of the variable offset masts can eliminate the need for custom length masts and mast extensions. Quick-connect/release pins allow for fast and easy setup, dismantle and transport.

1 Winch

Davits can be equipped with both primary and secondary (back-up) mechanical devices for added flexibility.

2 Quick-mounting brackets

Simple detent-style winch mounting brackets make installation fast and efficient.

3 3-way SRL

Davits can be equipped with both primary and secondary (back-up) mechanical devices for added flexibility.

4 Lower mast extensions

Allow the user to increase the overall anchorage height of the system.

5 Base options

Several portable and fixed base options are available for complete versatility.

6 Variable offset mast

Adjustable length of davit ensures lifelines are always centered over confined space.

7 Built-in pulleys

Route lifelines of two mechanical devices for smooth, efficient operation.

8 Fall arrest anchorage

Up to a 5,000 lb (22 kN) rated anchor point for fall arrest device.

9 Adjustable height

Eliminates the need for custom length masts and extensions.

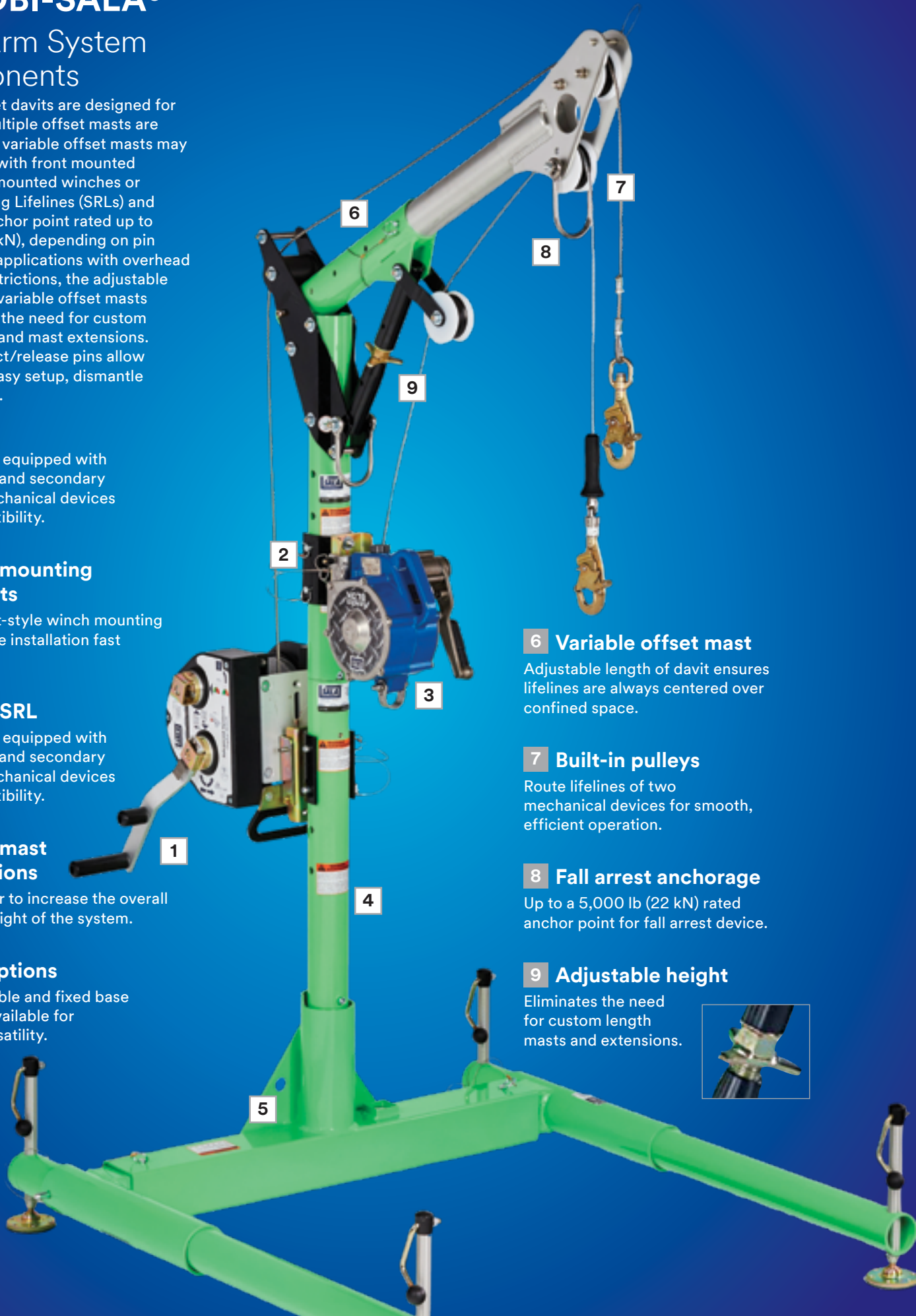

3M™ DBI-SALA®

One-Piece Adjustable Offset Davit Masts



Adjustable Offset Davit Mast	66" - 76" (167.6 cm - 193 cm)	78" - 88" (198.1 cm - 223.5 cm)	90" - 100" (228.6 cm - 254 cm)	69-1/2" - 87-1/2" (176.5 cm - 222.2 cm)	81-1/2" - 91-1/2" (207 cm - 232.4 cm)	93-1/2" - 111-1/2" (237.5 cm - 282.2 cm)
11-1/2" - 27-1/2" (29.2 cm - 69.8 cm)	8518382	8518383	8518384	-	-	-
23-1/2" - 42-1/2" (59.7 cm - 108 cm)	-	-	-	8518385	8518386	8518387

3M™ DBI-SALA®

Offset Davit Masts and Lower Mast Extensions

Customize either one of these davit masts with up to two Lower Mast Extensions. The extensions provide the flexibility to change the overall mast height of your system. Custom lengths are also available. Call us for details.

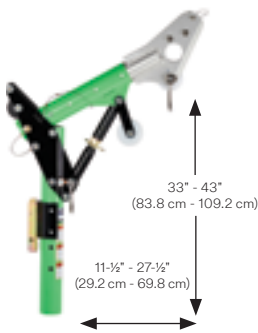

8518001 11-1/2" - 27-1/2" Adjustable Offset Davit Mast

(includes winch mount bracket)
Combine this one-piece davit mast with up to two lower mast extensions to increase the anchorage height. Combined extension length cannot exceed 90" (228 cm).

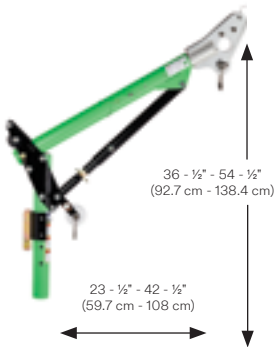

8518006 23-1/2" - 42-1/2" Adjustable Offset Davit Mast

(includes winch mount bracket)
Combine this one-piece davit mast with up to two lower mast extensions to increase the anchorage height. Combined extension length cannot exceed 78" (198 cm).

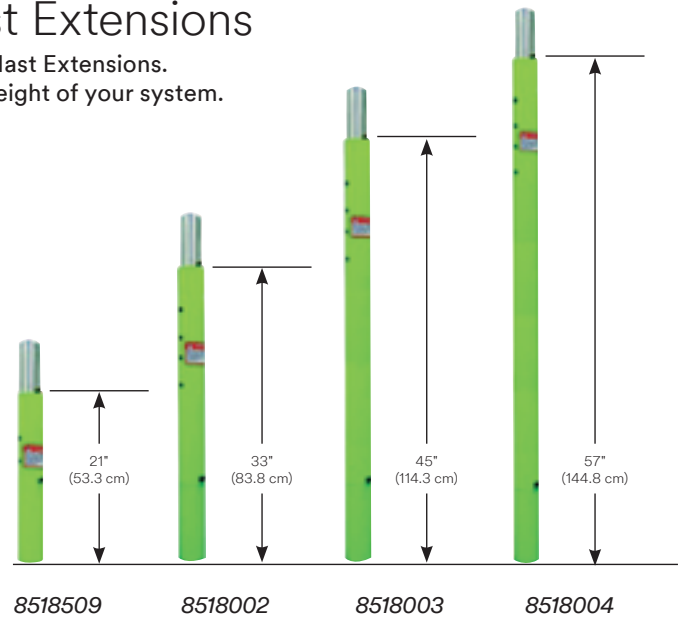

Part #	Description	Size
8518509	3M™ DBI-SALA® Lower Mast Extensions	21" (53.3 cm)
8518002	3M™ DBI-SALA® Lower Mast Extensions	33" (83.8 cm)
8518003	3M™ DBI-SALA® Lower Mast Extensions	45" (114.3 cm)
8518004	3M™ DBI-SALA® Lower Mast Extensions	57" (144.8 cm)

Bag



8513330 Carrying Bag

Bag with protective plastic liner for adjustable offset davit masts.

Part #	Description
8513564	3M™ DBI-SALA® Carrying Bag with protective plastic liner for adjustable offset davit mast, with lower mast extension

3M™ DBI-SALA®

Fixed Bases

Fixed Bases work with a variety of Davit Arm and Mast Extensions. They allow for easier setup and tear-down, making them an ideal solution for work areas where a base can be permanently installed to an existing structure.

3M™ DBI-SALA® Floor Mount Sleeve

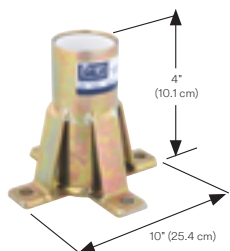

Mild steel construction. Mounts to horizontal concrete or steel structure. Comes with PVC sleeve liner.

Part #	Description
8516190	3M™ DBI-SALA® Floor Mount Sleeve: zinc plated mild steel construction, weight: 13 lb (5.9 kg)
8518347	3M™ DBI-SALA® Floor Mount Sleeve: stainless steel construction, weight: 13 lb (5.9 kg)

3M™ DBI-SALA® Wall Mount Sleeve

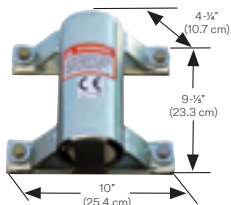

Compact design creates minimum intrusion into work space. Mounts to vertical concrete or steel structures. Comes with PVC sleeve liner.

Part #	Description
8518348	3M™ DBI-SALA® Wall Mount Sleeve: 304 stainless steel, weight: 12 lb (5.5 kg)
8516191	3M™ DBI-SALA® Wall Mount Sleeve: zinc-plated mild steel construction, weight: 12 lb (5.5 kg)

3M™ DBI-SALA® Center Mount Sleeve

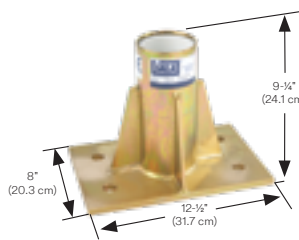

Mild steel construction. Mounts to existing steel by welding or bolting. Comes with PVC sleeve liner.

Part #	Description
8512831	3M™ DBI-SALA® Center Mount Sleeve: zinc plated, mild steel construction, weight: 13 lb (5.9 kg)
8516563	3M™ DBI-SALA® Center Mount Sleeve: stainless steel construction, weight: 13 lb (5.9 kg)

3M™ DBI-SALA® Core Mount Sleeve

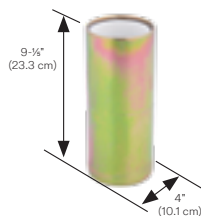

Zinc-plated mild steel construction. Designed for slip-in installation into 4" (10.1 cm) core hole in concrete or in an existing steel structure. Comes with PVC sleeve liner.

Part #	Description
8510109	3M™ DBI-SALA® Core Mount Sleeve: Zinc-plated mild steel construction, weight: 8 lb (3.6 kg)
8510110	3M™ DBI-SALA® Core Mount Sleeve: stainless steel construction, weight: 8 lb (3.6 kg)



3M™ DBI-SALA® Deck Mount Sleeve

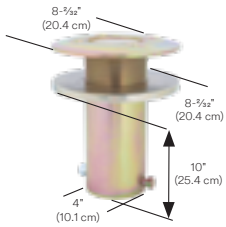

Designed to slip into a 4" (10.1 cm) hole in existing flooring. Flush mount design allows passage of traffic and eliminates trip hazards when not in use. Comes with PVC sleeve liner, plastic stopper and mounting hardware – mounts to thicknesses from 1/4" - 2" (6.4 mm - 50.8 mm).

Part #	Description
8515834	3M™ DBI-SALA® Deck Mount Sleeve: stainless steel construction, weight: 117 lb (7.7 kg)
8515162	3M™ DBI-SALA® Deck Mount Sleeve: zinc plated mild steel construction, weight: 117 lb (7.7 kg)

3M™ DBI-SALA® Flush Floor Mount Sleeve

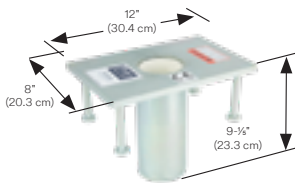

Mild steel construction. Comes with pins for fresh concrete and cast-in-place concrete anchors for new construction or renovation. Flush mount design allows passage of traffic and eliminates trip hazards when not in use. Comes with PVC sleeve liner.

Part #	Description
8510311	3M™ DBI-SALA® Flush Floor Mount Sleeve: mild steel construction, weight: 21 lb (9.5 kg)
8512828	3M™ DBI-SALA® Flush Floor Mount Sleeve: stainless steel construction, weight: 21 lb (9.5 kg)

3M™ DBI-SALA® Floor Mount Sleeve

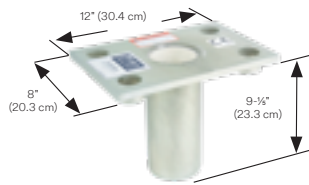

Mild steel construction. Recessed fastener pockets allow for bolt-in installation into existing concrete or steel structure. Flush mount design allows passage of traffic and eliminates trip hazards when not in use. Comes with PVC sleeve liner.

Part #	Description
8510316	3M™ DBI-SALA® Flush Floor Mount Sleeve: mild steel construction, weight: 21 lb (9.5 kg)
8512827	3M™ DBI-SALA® Flush Floor Mount Sleeve: stainless steel construction, weight: 21 lb (9.5 kg)

3M™ DBI-SALA® Offset Floor Mount Sleeve

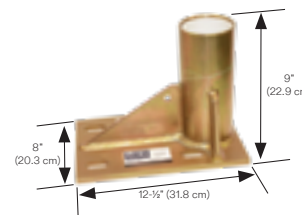

Mounts to horizontal concrete or steel structure. The offset design allows for maximum reach of the mast being used. Comes with PVC sleeve liner. Weight: 25 lb (11.3 kg)

Part #	Description
8510057	3M™ DBI-SALA® Offset Floor Mount Sleeve: zinc plated mild steel construction, weight: 25 lb (11.3 kg)

3M™ DBI-SALA® Heavy-Duty Sleeve Cap

Used with permanent mounted sleeves when installed in high traffic or other severe service locations.

Part #	Description
8510826	3M™ DBI-SALA® Heavy-Duty Sleeve Cap: zinc-plated mild steel construction, weight: 1.2 lb (0.54 kg)
8510827	3M™ DBI-SALA® Heavy-Duty Sleeve Cap: stainless steel construction, weight: 1.2 lb (0.54 kg)



3M™ DBI-SALA®

Hoist Systems

Adaptability and portability. They're both essential to successful manhole or confined space entry and retrieval. That's why we've engineered our Hoist Systems with lightweight materials like high-strength aluminum and made them adjustable and extendable to meet the specific needs of your job site. If you're not sure what you need, please call us and we'll create your customized solution to maximize ease-of-rescue—even in complex environments.

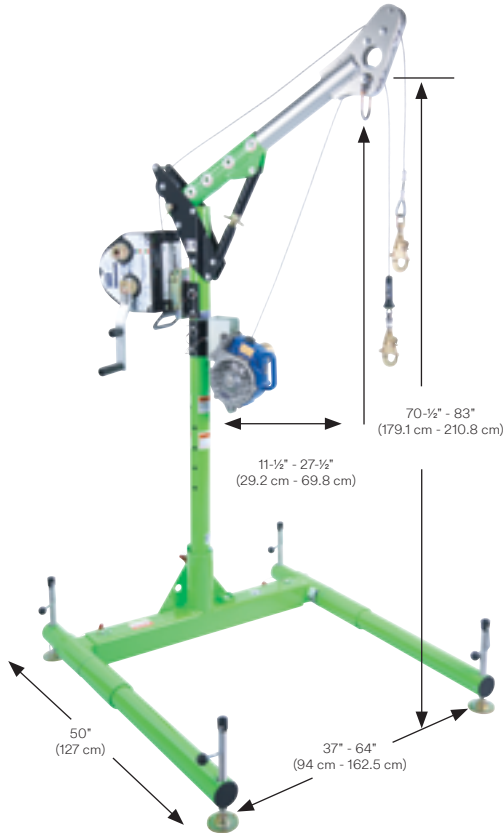

8300009

3M™ DBI-SALA®

5-Piece Hoist System

Davit arm and base system includes 11-½" - 27-½" (29.2 cm-69.8 cm) Adjustable Offset Upper Mast (8518001), 33" (83.8 cm) Lightweight Lower Mast (8518002), and 3-Piece Lightweight Base (8518005). Includes winch mounting bracket. Order winch and Self-Retracting Lifeline separately. Weight: 100 lb (45.5 kg)

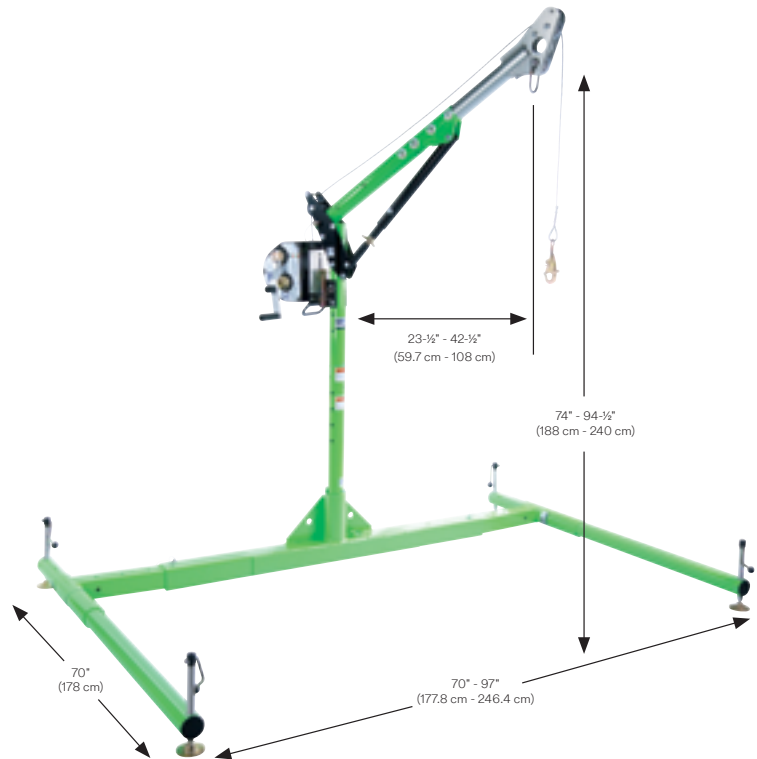

8518040

3M™ DBI-SALA®

5-Piece Hoist System

Davit arm and base system includes 23-½" - 42-½" (59.7 cm-108 cm) Adjustable Offset Upper Mast (8518006), 33" (83.8 cm) Lightweight Lower Mast (8518002), and 3-Piece Lightweight Base (8518008). Includes winch mounting bracket. Order winch separately. Weight: 137.5 lb (62.3 kg)

Confined Space Rescue

8530352

3M™ DBI-SALA®

Advanced™ 4-in-1 Davit Guard System

Provides a basic hoist and a passive restraint guardrail system protecting companion workers and bystanders. This lightweight aluminum structure assembles and adjusts without tools. It features a collapsible base to reduce storage and transport space. A standard tie-off point provides a convenient 5000 lb (22 kN) anchor point for fall arrest devices where required.



3M™ DBI-SALA®

5-Piece Equipment Cart

Transport the 5-Piece System with maximum ease over smooth or rough terrain. Ideal for tight storage situations.

Part #	Description
8518270	3M™ DBI-SALA® 5-Piece Equipment Cart
8518513	Set of two 3M™ DBI-SALA® Carrying bags for 5-piece hoist



3M™ DBI-SALA®

Portable Bases

Portable Bases work with a variety of Davit Arm and Mast Extensions. They're ideal when you need to move and access various confined space areas. Bases are lightweight, easy to transport, set up and use.

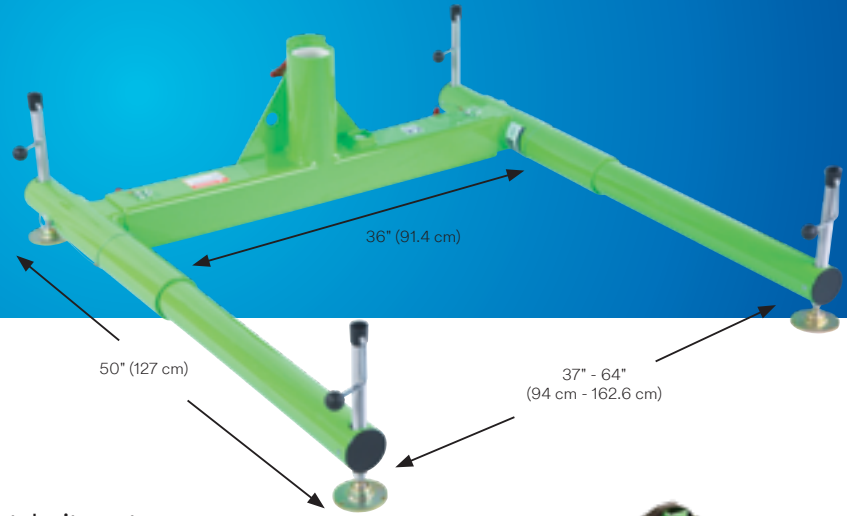

3M™ DBI-SALA®

3-Piece Portable Base

Adjustable base for 27-½" (69.8 cm) maximum offset davit mast.

Part #	Description
8518008	3M™ DBI-SALA® 3-Piece Portable Base. Adjustable base for 42-½" (108 cm) maximum offset davit mast
8513565	3M™ DBI-SALA® Carrying Bag with protective plastic liner for 3-piece davit base
8518005	3M™ DBI-SALA® 3-Piece Portable Base: Adjustable base for 27-½" (69.8 cm) maximum offset davit mast



8519377

3M™ DBI-SALA®

External Tank Cover

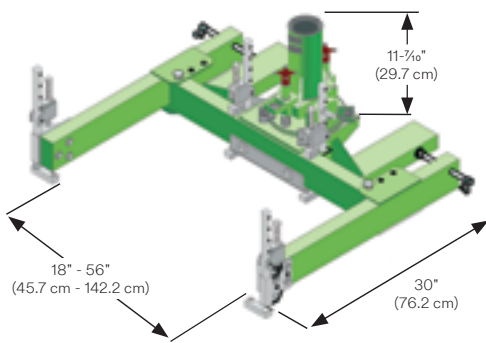

Comes with Adjustable Sleeve Assembly (8511232). Used on manways with a flange structure that the unit may be secured onto. This collar can clamp onto 6" (15.2 cm) max thick flange. Weight: 82 lb (37.2 kg)

8510568

3M™ DBI-SALA®

Forklift Basket

Designed to convert your forklift into a versatile confined space and fall arrest work platform. Add a davit mast and winch/Self-Retracting Lifeline to the basket and you're ready to go. Lightweight aluminum construction and tool-free assembly simplifies setup, transport and storage. Durable powder coated finish with anti-slip finish on walking surfaces. Includes spring-loaded gate. Weight: 215 lb (98 kg)

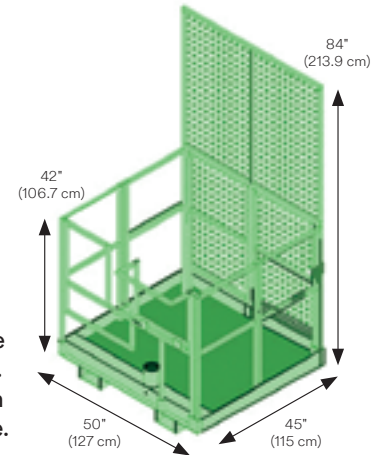

3M™ DBI-SALA®

Barrel Mount Sleeves

Mild steel construction. Eight independent clamping screws allow temporary installations over edges of shoring cans, walls and other structures. Comes with PVC inner liner. Custom fit openings available.

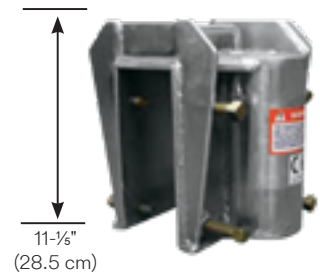

Part #	Description
8510429	3M™ DBI-SALA® Barrel Mount Sleeve with 3.5" (89 mm) opening, stainless steel
8510323	3M™ DBI-SALA® Barrel Mount Sleeve with 3.5" (89 mm) opening, plated steel

Confined Space Rescue

3M™ DBI-SALA®

Adjustable Barrel Mount Sleeves

Designed for shoring, wall and parapet applications. Standard unit accommodates wall thicknesses up to a maximum of 24" (60.9 cm), with shorter or longer adjustment tubes available on request. Anodized, welded aluminum with zinc-plated steel hardware with inner sleeve.

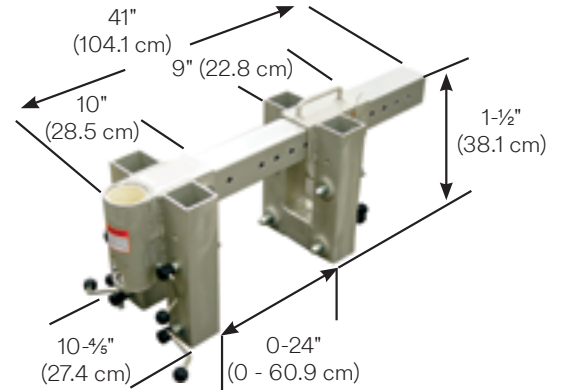

Part #	Description
8510429	3M™ DBI-SALA® Adjustable Barrel Mount Sleeve for 0" - 12" opening
8512285	3M™ DBI-SALA® barrel mount sleeve, anodized aluminum, adjustable to 12-24" opening
8510712	3M™ DBI-SALA® barrel mount sleeve, anodized aluminum, adjustable to 12" opening

3M™ DBI-SALA®

Manhole Collars

Provides a Portable Davit Base by simply fitting within manhole opening. Powder coated aluminum construction with PVC sleeve liner.



Part #	Description	Size (dia.)
8510501	3M™ DBI-SALA® Manhole Collar: 17-1/2" (44.5 cm)	18" - 20" (45.7 cm - 50.8 cm)
8510520	3M™ DBI-SALA® Manhole Collar 19-1/2" (49.5 cm)	20" - 22" (50.8 cm - 55.8 cm)
8510457	3M™ DBI-SALA® Manhole Collar 21-1/2" (54.6 cm)	22" - 24" (55.8 cm - 60.9 cm)
8510163	3M™ DBI-SALA® Manhole Collar 23-1/2" (59.7 cm)	24" - 26" (60.9 cm - 66 cm)
8510633	3M™ DBI-SALA® Manhole Collar 25-1/2" (64.7 cm)	26" - 28" (66 cm - 71.1 cm)
8510632	3M™ DBI-SALA® Manhole Collar 27-1/2" (69.8 cm)	28" - 30" (71.1 cm - 76.2 cm)
8510546	3M™ DBI-SALA® Manhole Collar 29-1/2" (74.9 cm)	30" - 32" (76.2 cm - 81.2 cm)
8512994	3M™ DBI-SALA® Manhole Collar 33-1/2" (83.1 cm)	34" - 36" (86.3 cm - 91.4 cm)

3M™ DBI-SALA®

Vehicle Hitch Mount Sleeves

Designed to install into a 2" (5.1 cm) hitch receiver on an attendant vehicle to provide a portable anchor point for confined space entry, rescue and fall arrest systems.

Part #	Description
8510140	3M™ DBI-SALA® Vehicle Hitch Mount Sleeve Assembly for a maximum 27-1/2" (69.8 cm) offset davit mast
8514461	3M™ DBI-SALA® Vehicle Hitch Mount Sleeve Assembly for a maximum 42-1/2" (108 cm) offset davit mast

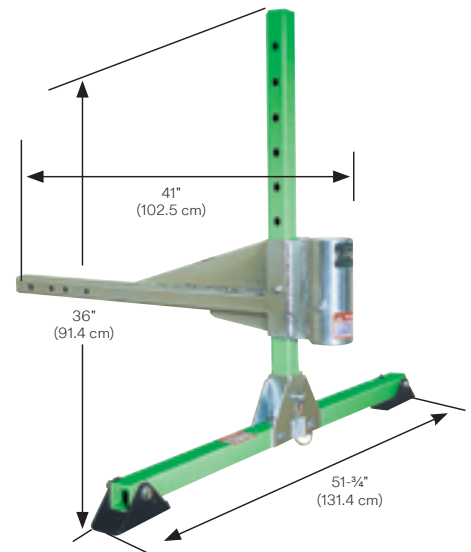

3M™ DBI-SALA®

Tripods

Our Tripods are constructed of lightweight tubular aluminum with a rugged steel head assembly. The UCT Series Tripods can be combined with up to three pulleys to accommodate a variety of winches and fall arrest devices, meeting a wide range of confined space entry/retrieval and rescue requirements. Quick-release pins positively locate components at all adjustment points for tool-free setup and adjustment.

1 Mechanical devices

Can support up to three winches or Self-Retracting Lines (SRLs) for complete flexibility.

2 Quick-connect bracket

Allows fast and easy attachment of mechanical devices.

3 Safety chain

Provides added support and strength for demanding confined space applications.

4 Top mounted pulley system

Mount up to three pulleys to route mechanical device lifelines for smooth operation.

5 Secondary anchor point

5,000 lb (22 kN) anchor point for secondary fall arrest system.

6 Aluminum construction

Extremely lightweight yet durable construction for ease-of-use and longevity.

7 Telescoping legs

Provide fast adjustment and cannot disengage, for added worker satisfaction.

8 Adjustable height legs

Fast and easy detent pin-style adjustment allows for precise height setting.

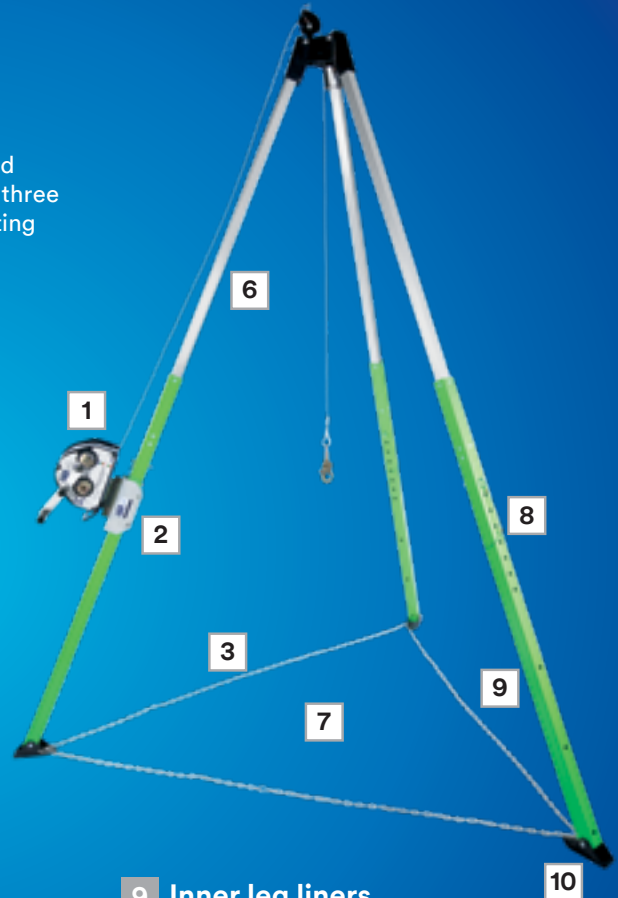

9 Inner leg liners

Allow for smooth positive connection and operation of leg adjustment.

10 Foot pads

Include sharp points for biting into soft ground and/or uneven terrain.

3M™ DBI-SALA® Advanced™ Tripod

Part #	Tripod	Height	Capacity	Lifeline Type	Lifeline Length	Lifeline
8000014	Aluminum tripod	7' (2.1 m)	350 lb (159 kg)	-	-	-
8000015	Aluminum tripod	9' (2.7 m)	350 lb (159 kg)	-	-	-
8300030	Aluminum tripod with Salalift™ II Winch	7' (2.1 m)	350 lb (159 kg)	Galvanized cable	60' (18 m)	¼" (6.4 mm) dia. galvanized aircraft wire rope
8301055	Tripod, Salalift™ II Winch and Sealed-Blok 3-Way SRL	7' (2.1 m)	Winch/Tripod = 350 lb (159 kg), SRL = 75 - 310 lb (34 - 141 kg)	Galvanized cable	Winch = 60' (18 m) SRL = 50' (15.2 m)	Winch = ¼" (6.4 mm) dia. Galvanized Aircraft Wire Rope, SRL = ⅜" (5 mm) dia. 7×19 galvanized aircraft wire rope
8301050	Aluminum tripod with Sealed-Blok 3-Way SRL	7' (2.1 m)	75-310 lb (34 - 141 kg), SRL = 75 - 310 lb (34 - 141 kg)	Galvanized cable	50' (15.2 m)	⅜" (5 mm) dia. galvanized aircraft wire rope
8301056	Tripod, Salalift™ II Winch and Sealed-Blok 3-Way SRL	7' (2.1 m)	Winch/Tripod = 350 lb (159 kg), SRL = 75 - 310 lb (34 - 141 kg)	Stainless steel cable	Winch = 60' (18 m) SRL = 50' (15.2 m)	Winch = ¼" (6.4 mm) dia. stainless steel aircraft wire rope, SRL = ⅜" (5 mm) dia. stainless steel aircraft wire rope

8000014

3M™ DBI-SALA®

Advanced Aluminum Tripod

- 7' (2.1 m) aluminum tripod
- Telescoping adjustable locking legs
- Built-in pulley system
- Rubber safety shoes with spiked edges
- Safety leg support chain
- Integrated 5,000 lb (22 kN) eyebolt anchor points
- Quick connect winch/SRL mount bracket
- Equipped with i-Safe™
- Also available in 9' (2.7 m) length : 8000015

Winch and SRL not included—order separately.



8513158

3M™ DBI-SALA®





UCT-300 7' (2.13 m) Tripod

- Lightweight, durable aluminum construction with powder coat finish.
- Includes quick-connect winch mount bracket— can accommodate up to three brackets.
- Includes top mounted pulley system— can accommodate up to three pulleys.
- Telescoping adjustable locking legs for easy setup.
- Fast detent pin-style adjustment and locking adjustment
- Inner plastic liners provide smooth.
- Foot pads include sharp points for biting into soft ground or uneven terrain
- Safety chain for added support, strength and safety.
- 5,000 lb (22 kN) built-in head mounted anchor point.
- Capacity: 450 lb (204.1 kg)
- 8513159 UCT-1000 Tripod, 10' (3 m)

Winch and SRL not included—order separately.



Hardware and Accessories

Part #	Description	
8512292	3M™ DBI-SALA® Winch/SRL Mounting Bracket for UCT-1000 Tripod (8513159): Attaches to the leg tube with quick-release pins for tool-free setup and adjustment. Weight: 5.2 lb (2.4 kg)	
8510224	3M™ DBI-SALA® Winch/SRL Mounting Bracket for UCT-300 Tripod (8513158): Attaches to the leg tube with quick-release pins for tool-free setup and adjustment. Weight: 3 lb (1.4 kg).	
8512293	3M™ DBI-SALA® Top Pulley Assembly for UCT Series Tripods: Pulleys are mounted on top of the head assembly to route mechanical device's lifeline over and into confined space area. Weight: 1.6 lb (0.73 kg)	
8513330	3M™ DBI-SALA® Carrying Bag for 10' (3 m) Tripod with protective plastic liner (8513159).	
8513329	3M™ DBI-SALA® Carrying Bag for 7' (2.1 m) Tripod with protective plastic liner (8513158).	

Confined Space Rescue

3M™ DBI-SALA®

The Pole Hoist attaches with a carabiner on the universal bracket to a suitable anchor point, allowing you to work in any direction from any angle. It has a unique swivel head that rotates 360 degrees, providing flexibility in both vertical and horizontal confined space entries. Two systems that adjust from either 4' - 7' (1.2 m - 2.1 m) or 6' - 10' (1.8 m - 3 m) are available for job site flexibility and to better position the attendant in close working quarters. Custom lengths are also available. Please call us for details.



3M™ DBI-SALA®

Extendable Pole Hoists

Extension with swivel head and winch mounting bracket, T-bar leg assembly and hardware/fasteners.



Part #	Description
8530252	3M™ DBI-SALA® Extendable Pole Hoist 4' - 7' (1.2 m - 2.1 m), weight: 12 lb (5.4 kg)
8530253	3M™ DBI-SALA® Extendable Pole Hoist 6' - 10' (1.8 m - 3 m), weight: 14 lb (6.4 kg)

3M™ DBI-SALA®

Pole Hoist Accessories

2104550

Steel Anchor Plate with D-Ring



This plate anchor offers a compact, reliable attachment to $\frac{3}{8}$ " - 1" (0.9 cm - 2.5 cm) thick plate steel for connecting your lanyard, vertical lifeline system or self-retracting lifeline.

8520777

Clamp-On Anchor for Pole Hoists



Designed to secure to a vertical or horizontal flange up to 6" (15.2 cm) thick and provide an anchorage point to connect a pole hoist device to.

Carrying Bag



Part #	Description	Size
8513330	3M™ DBI-SALA® Carrying Bag for Pole Hoist	6' - 10' (1.2 m - 2.1 m)
8513329	3M™ DBI-SALA® Carrying Bag for Pole Hoist	4' - 7' (1.2 m - 2.1 m)

3M™ DBI-SALA®

Portable Fall Arrest Posts

Enhance protection. Maintain mobility. Our Portable Fall Arrest Post makes it possible for up to three workers on top of transformers or other types of vertical platforms with potential fall hazards. It's compact and easy to transport and set up at only 38 lb (17.2 kg). The system features a telescopic design and three swiveling anchor points, delivering 360 degrees of protection and mobility. Portable and fixed bases maximize versatility on your job site.



Telescopic design: Overall height can be adjusted from 32-3/4" - 57-1/4" (83.2 cm - 145.4 cm)



8516691

3M™ DBI-SALA® Portable Fall Arrest Post

- Three independent swiveling tie-off points.
 - 360 degrees of protection for three workers.
 - Telescopic design; 32-3/4" - 46" - 57-1/4" (83.2 cm - 116.8 cm - 145.4 cm).
 - Lightweight and durable aluminum construction.
 - Leveling screws plumb system on inclines up to 15 degrees.
 - Built-in anchor ring for horizontal lifeline attachment.
 - Portable and fixed bases provide complete job site versatility.
- Weight: 38 lb (17.5 kg)



8516693

3M™ DBI-SALA® Rescue Davit Arm for Portable Fall Arrest Post

The optional Rescue Davit Arm assembles easily to our portable fall arrest post, providing simple and efficient rescue and material handling capabilities. It's made with lightweight aluminum materials for easy transportation and setup. Weight: 20.5 lb (9.3 kg)

8516691 post not included—order separately.

Accessories:

Part #	Description	
8516692	3M™ DBI-SALA® 14" (356 mm) Anchor Post Extension: Provides option to tie-off one worker at an increased height of 68-1/2" (174 cm) Weight: 5 lb (2.2 kg)	
8517565	3M™ DBI-SALA® Carrying Bag: Heavy-duty carrying bag for Portable Fall Arrest Post	



Confined Space Rescue

3M™ DBI-SALA®

Anchor Bases for Portable Fall Arrest Post

Part #	Description	
8517412	3M™ DBI-SALA® Bare Steel Uni-Anchor with Tie-Off Anchors: for use in closed environments without chemical or moisture exposure, weight: 11.6 lb (5.3 kg)	
8517415	3M™ DBI-SALA® Mounting Plate with Tie-off Anchors, sand blasted stainless steel, weight: 11.6 lb (5.3 kg)	
8517413	3M™ DBI-SALA® Incline Adapter with Tie-Off Anchor: permanently weld to inclined surface, weight: 24 lb (10.9 kg)	



3M™ DBI-SALA® Mechanical Systems

Retrieving incapacitated workers and bringing them to safety makes the mechanical device one of the most critical parts of your rescue system. Choosing the right lifeline type and length are just a few of the options. In some situations, you may need a secondary or backup system, too.

1 Digital Winches

- Man rated 450 lb (204 kg) capacity.
- Digital usage indicator tracks drum revolutions to determine service intervals.
- Triple redundant braking system for added safety.
- Sealed bearings at all contact points.
- Two gear ratio options of 4:1 and 9:1.
- Power drive option available.
- Three sizes accommodate 70' - 300' (21 m - 91 m) lengths.
- Cable and rope lifelines with swiveling snap hook and overload indicator.
- Carrying handle for easy transport.
- Corrosion-resistant, zinc-plated steel or anodized aluminum hardware.

2 3-Way Sealed-Blok Self-Retracting Lifeline

Ideal for secondary or back-up.

- Man rated 420 lb (190 kg) capacity.
- Fall arrest system limits forces to 900 lb (4 kN).
- Built-in emergency retrieval winch.
- Input handle with primary brake.
- Overload device in winch drive.
- Sealed ball bearings.
- Corrosion-resistant aluminum and stainless steel construction.
- Five sizes accommodate 30' - 130' lengths (9 m - 40 m).
- Cable and rope lifelines with swiveling snap hook and impact indicator.
- Carrying handle for easy transport.

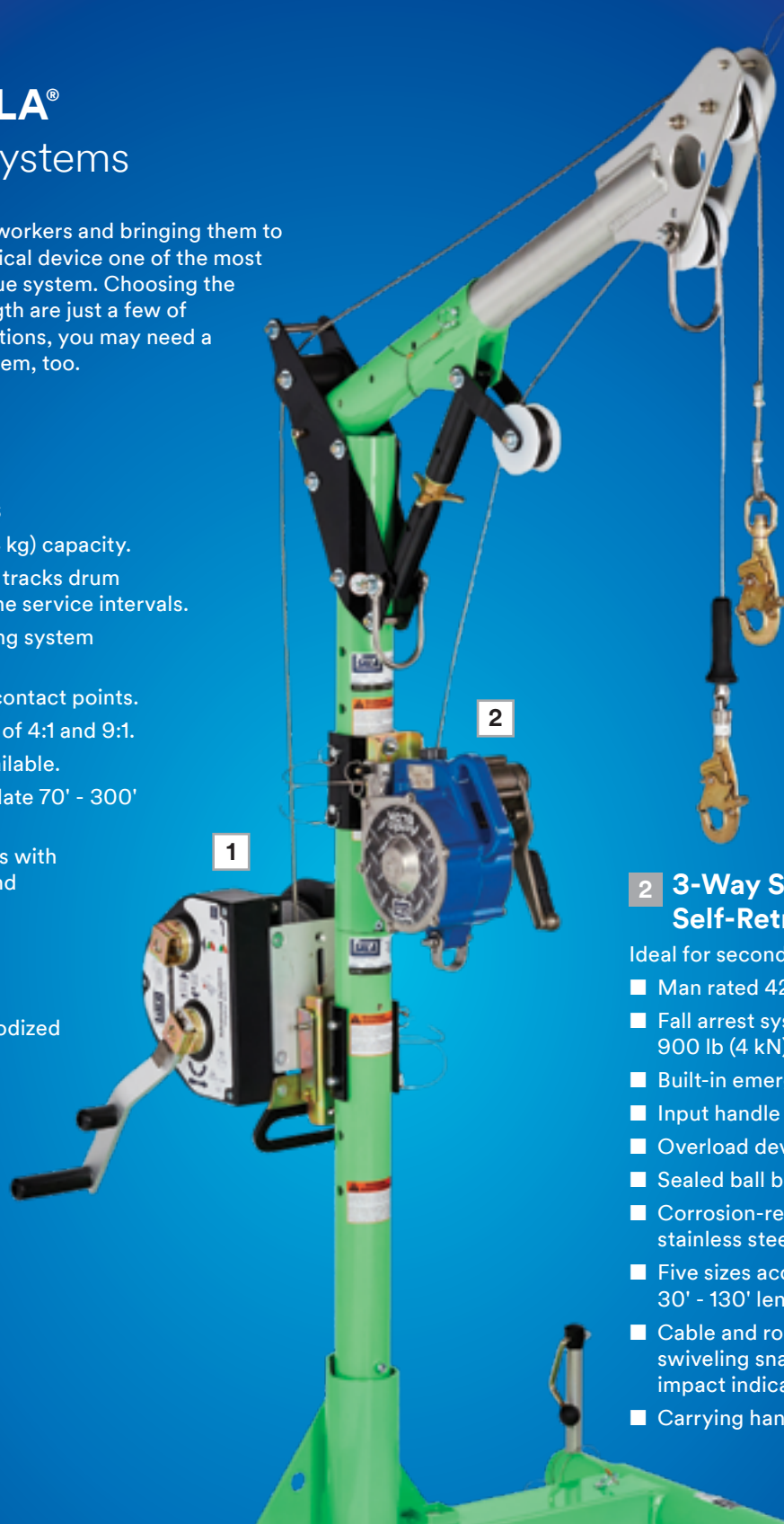

Salalift II Winches

- Man rated 350 lb (159 kg) capacity.
- Overload clutch.
- Gear ratio of 6:1.
- Free-wheel mode.
- Shielded ball bearings.
- Lengths from 60' - 120' (18 m - 36.5 m) available.
- Cable and rope lifelines with swiveling snap hook and impact indicator.
- Carrying handle for easy transport.
- Corrosion-resistant construction.
- Quick-mount bracket and carrying bag.

3M™ DBI-SALA® Winches



Digital Winch



Salalift™ II Winch

Drive type	Lifeline type	Mounting bracket	Winch bag	Digital winch	Salalift II Winch	50' (15.2 m)	60' (18 m)	90' (27 m)	120' (36.5 m)	140' (42 m)	190' (58 m)	240' (73 m)	290' (88 m)
Power drive*	Galvanized steel	■		■			8518567	8518568		8518588	8518589	8518610	8518611
	Stainless steel	■		■			8518565	8518566		8518586	8518587	8518608	8518609
	Technora® rope	■		■			8518571						
Removable handle	Galvanized steel	■		■			8518560	8518561		8518581	8518582	8518603	8518604
		■	■		■		8102060	8102009	8102005				
	Stainless steel	■		■			8518558	8518559		8518579	8518580	8518601	8518602
		■	■		■		8102022	8102011	8102007				
	Technora rope	■		■			8518564						
		■	■		■	8102050							
Cable model weight							30-½ lb (13.8 kg)	32-½ lb (14.7 kg)	38-½ lb (17.5 kg)	40 lb (18.4 kg)	43 lb (19.5 kg)	50 lb (22.6 kg)	53-½ lb (19.5 kg)
Technora rope model weight						27 lb (12.2 kg)	27 lb (12.2 kg)						

The Salalift™ II Winch includes a mounting bracket and carrying bag.
*Power drive units require Overload Protection Clutch (8512936)—not included.

3M™ DBI-SALA® 3-Way Self-Retracting Lifelines



3-Way Sealed-Blok SRL – RSQ



3-Way Sealed-Blok SRL

Cable type	Sealed-Blok	Sealed-Blok without bracket	Sealed-Blok/RSQ	Ultra-Lok	30' (9.1 m)	50' (15.2 m)	85' (25.9 m)	130' (39.6 m)	175' (52.5 m)
Galvanized steel	■				3400853C	3400923C	3400876	3400981	
		■			3400850C	3400920C	3400875		
			■				3400913		
				■					
Stainless steel	■				3400858C	3400926C	3400883	3400988	
		■			3400852C	3400922C	3400879	3400984	3400661
			■				3400915		
				■					

3M™ DBI-SALA® Winch Brackets and Accessories

3M™ DBI-SALA® Adjustable Ladder Bracket

Designed to allow use of the ladder section(s) 8518507 with various base, sleeve and mast options. Installs over mast/extension.



Part #	Description
8518506	3M™ DBI-SALA® Adjustable Ladder Bracket

3M™ DBI-SALA® Ladder Section

Complete with connector channels and positive pin locks. Can be connected to additional ladders (up to five sections) for a maximum length of 32' (9.75 m).



Part #	Description
8518508	3M™ DBI-SALA® 4' Ladder Section
8518507	3M™ DBI-SALA® 8' Ladder Section

3M™ DBI-SALA® Retrieval Wristlets

Rescue/retrieval design is ideal for connection to victim's wrists for narrow extractions.



Part #	Description
1001220	Attached with an O-ring at one end x 18" (0.46 m)
1001210	Yoke wristlets attached to Y-lanyard with D-ring at end x 2' (0.6 m)

3M™ DBI-SALA® Padded Carrying Bag



Part #	Description
8517567	3M™ DBI-SALA® Padded Carrying Bag for digital winch

3M™ DBI-SALA® Overload Protection Clutch



Part #	Description
8512936	3M™ DBI-SALA® Overload Protection Clutch: features a maximum working load of 450 lb (204.1 kg)

3M™ DBI-SALA® Mounting Bracket

Part #	Description
8549915	3M™ DBI-SALA® Mounting Bracket

3M™ DBI-SALA® Mating Bracket



Part #	Description
3590499	This mating bracket is used to mount the Protecta® Rebel™ Retrieval to a DBI-SALA® Tripod or UCL Tripod Davit.

3M™ DBI-SALA® Tripod Base

Part #	Description
8005050	This base connects to a Protecta® AK105A or M100 series tripod. It then allows any DBI-SALA® Winch or 3-way SRL with mating bracket to be connected and used with the Protecta® Tripod.

3M™ DBI-SALA® Winch/SRL Adapter with Flat Back



Part #	Description
8510207	3M™ DBI-SALA® Winch/SRL Adapter with Flat Back to attach 3M™ DBI-SALA® Winch/SRL to structures

3M™ DBI-SALA® Quick-Release Mounting Bracket



Part #	Description
8516824	3M™ DBI-SALA® Quick-Release Mounting Bracket for upper and lower masts

3M™ DBI-SALA® Y-Lanyard

Rescue/retrieval design ideal for use with harness incorporating shoulder D-rings. Spreader bar with snap hooks at ends, D-ring at centre x 2' (0.6 m)



Part #	Description
1231470	Y-Lanyard without spreader bar x 2' (0.6 m)
1231460	Spreader bar with snap hooks at ends, D-ring at centre x 2' (0.6 m)



Flexiguard™ Solutions

Flexiguard™ Solutions



Maximum safety to give you peace of mind. Flexiguard™ is designed to meet the requirements of your specific application.

Durable

Powder-coated, anodized high strength alloy.
Specifically engineered for extra tall and wide applications.
Enclosed rail to help keep debris out (weather elements).
100% fall arrest rated tie-off from the ground up.
SAE J429 Grade 8 hardware with zinc yellow Chromate-plated finish.

Portable

Lightweight design—easily moved by minimal personnel.
Most allow for positioning by a forklift or other service vehicle.
Heavy-duty stabilization for use on uneven ground.

Versatile

Indoor and outdoor use.
Multiple overhead anchor points on systems that are designed for multiple users.
Provides a large, safe working area — working radius from rail is 6' (1.8 m) or 30 degrees.
Rigid anchor points have no deflection or sag, reducing fall clearance requirements.
Systems can be permanently mounted (where applicable).
Flexiguard™ custom solutions meet the needs of specific and challenging work environments.

We help make worker safety a priority. From our researchers and developers to our industry-leading installation, training services and annual inspections, 3M offers unique solutions for unique needs.

Our global engineering and manufacturing teams test and certify each product to ensure it meets, and often exceeds the latest regulatory requirements.



Ideal applications include:

TRANSPORT 	CONSTRUCTION 	UTILITIES
OIL AND GAS 	MINING 	WIND ENERGY

Flexiguard™ Solutions

3M™ DBI-SALA®

Flexiguard™ Modular Jib System.

Get the coverage you need with this versatile new fall protection system. Available in both the M100 and M200 Series, the 3M™ DBI-SALA® Flexiguard™ Modular Jib System features a simplified design that enhances worker safety in multiple applications. Increased rail-length configurations improve working coverage while a new design facilitates easier system transport. Complies with OSHA 1962.502, OSHA 1910.140, EN795.2012, CEN/TS 16415:2013. For use in Canada, please review applicable provincial regulations.

- Extended reach offers up to 10 ft. (3.5 m) more reach than previous models
- Increased height offers up to 5 ft (1.5 m) more vertical height than previous models
- Patent-pending fail-safe mast lock eliminates need for height locking fasteners like pins and bolts
- Patent-pending weight distribution simplifies transport using 5,000 lb. rated (2,268 kg) forklift for all counterweight models.

M100 3M™ DBI-SALA® Flexiguard™ M100 Modular Jib Systems

1 Choose from 7 interchangeable mast options.

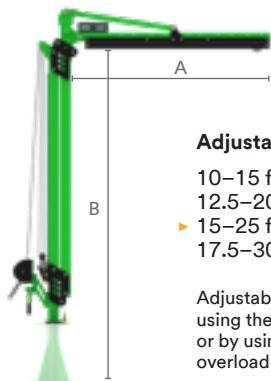

Adjustable Height, Single User Masts

- 10–15 ft. (3–4.6 m) **8530874**
- 12.5–20 ft. (3.8–6.1 m) **8530875**
- ▶ 15–25 ft. (4.6–7.6 m) **8530876**
- 17.5–30 ft. (5.3–9.1 m) **8530877**

Adjustable height masts are adjusted easily using the integrated hand crank winch, or by using a power drill with the optional overload clutch accessory equipped.

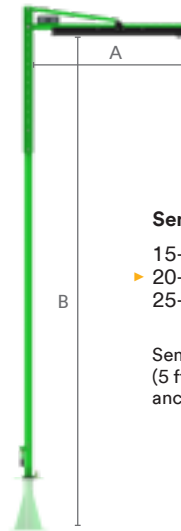

▶ = Model shown

Semi-Fixed Height, Single User Masts

- 15–20 ft. (4.6–6 m) **8530882**
- ▶ 20–25 ft. (6–7.6 m) **8530883**
- 25–30 ft. (7.6–9.1 m) **8530884**

Semi-fixed masts offer a small amount (5 ft. or 1.5 m) of adjustment to optimize the anchor height during installation.

2 Choose from 5 interchangeable base options.

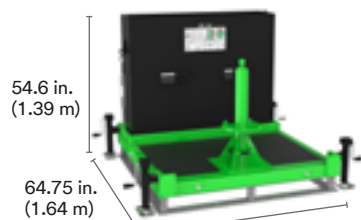

79.25 in. (2.01 m)
With leveling jacks installed
60 in. (1.52 m)
Without leveling jacks installed

Portable Counterweight Base*
With concrete fill **8530870**
Without concrete **8530869**

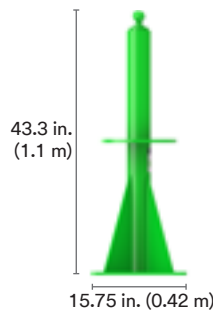

Floor Mounted Base
8530871

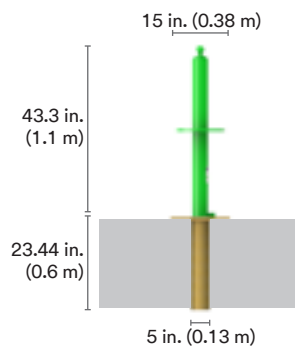

Flush Mounted Base
8530872

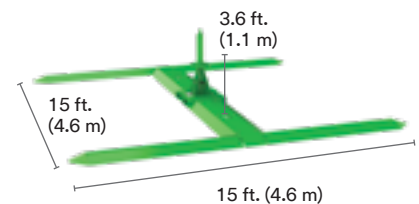

Outrigger Base
8530873

*Portable Counterweight Base includes leveling jacks

3 Choose your accessories.



Confined Space and Rescue Pulley Kit

8530885

Enables a rescue device to be mounted to the system. Includes mounting brackets and re-direct pulleys. Rescue devices sold separately.

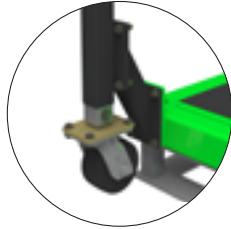

Smooth Surface Caster Kit

8530908

Allows counterweight base systems to be maneuvered into tight spaces on smooth surfaces.

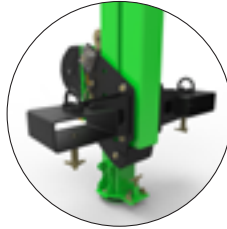

Forklift Pocket Mast Transport Kit

8530911

Allows mast to be separated from the base and transported vertically using a forklift.



Overload Clutch

8512936

Required to raise and lower adjustable masts with a power drill. (Drill not included)



Counterweight Box Lifting Ring Kit

8530914

Allows counterweight box to be moved with overhead lifting equipment. Includes two rings per kit. One kit needed per counterweight system.

Part #	Total System Weight	Max. Component Weight	Offset/Reach (A)	Height (B)	Mast Rotation Range	# of Users	SRL Maximum Arresting Force
M100	4,995 lb (2,266 kg)	3,095 lb. (1,404 kg)	7.5 ft. (2.3 m)	Up to 30 ft. (9.1 m)	270° with counterweight base. 360° with others.	1	1,350 lb. (6 kN)

M200 3M™ DBI-SALA® Flexiguard™ M200 Modular Jib Systems

1 Choose from 14 interchangeable mast options.

▶ = Model shown

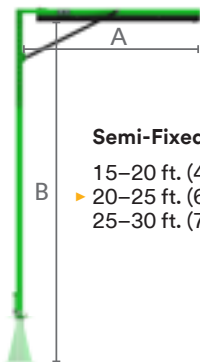

Semi-Fixed Height, Single User Masts

- 15–20 ft. (4.6–6 m) **8530899**
- ▶ 20–25 ft. (6–7.6 m) **8530900**
- 25–30 ft. (7.6–9.1 m) **8530901**

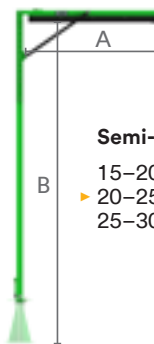

Semi-Fixed Height, Dual User Masts

- 15–20 ft. (4.6–6 m) **8530902**
- ▶ 20–25 ft. (6–7.6 m) **8530903**
- 25–30 ft. (7.6–9.1 m) **8530904**

Semi-fixed masts have a small amount (5 ft. or 1.5 m) of adjustment to optimize the anchor height during installation.

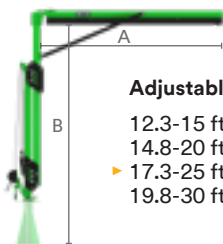

Adjustable Height, Single User Masts

- 12.3–15 ft. (3.8–4.6 m) **8530891**
- 14.8–20 ft. (4.5–6.1 m) **8530892**
- ▶ 17.3–25 ft. (5.3–7.6 m) **8530893**
- 19.8–30 ft. (6–9.1 m) **8530894**

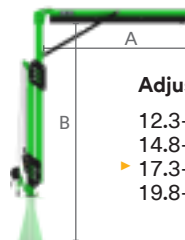

Adjustable Height, Dual User Masts

- 12.3–15 ft. (3.8–4.6 m) **8530895**
- 14.8–20 ft. (4.5–6.1 m) **8530896**
- ▶ 17.3–25 ft. (5.3–7.6 m) **8530897**
- 19.8–30 ft. (6–9.1 m) **8530898**

Adjustable height masts are adjusted easily using the integrated hand crank winch, or by using a power drill with the optional overload clutch accessory equipped.

Flexiguard™ Solutions

2 Choose from 4 interchangeable base options.

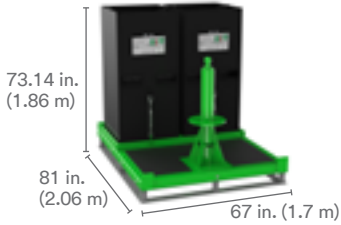

Portable Counterweight Base*
With concrete fill **8530887**
Without concrete **8530886**

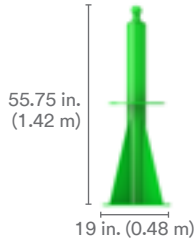

Permanent Floor Mounted Base
8530888

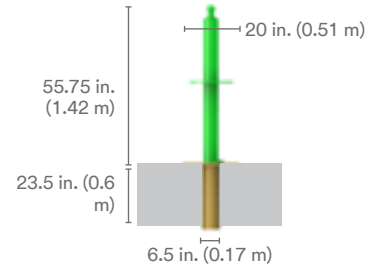

Permanent Flush Mounted Base
8530889

*Portable Counterweight Base optional leveling jacks sold separately

3 Choose your accessories.



Confined Space and Rescue Pulley Kit
8530905

Enables a rescue device to be mounted to the system. Includes mounting brackets and re-direct pulleys. Rescue devices sold separately.

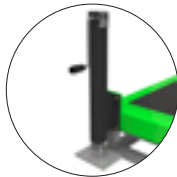

Jack Stabilizing Kit
8530907

Designed to stabilize and level counterweight base systems on slightly uneven surfaces.

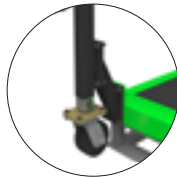

Smooth Surface Caster Kit
8530908

Allows counterweight base systems to be maneuvered into tight spaces on smooth surfaces.

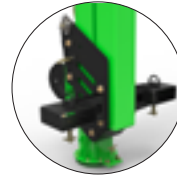

Forklift Pocket Mast Transport Kit
8530912

Allows mast to be separated from the base and transported vertically using a forklift.



Overload Clutch
8512936

Required to raise and lower adjustable masts with a power drill. (Drill not included)



Counterweight Box Lifting Ring Kit
8530777

Allows counterweight box to be moved with overhead lifting equipment. Includes four rings per kit. One kit needed per counterweight system.

Part #	Total System Weight	Max. Component Weight	Offset/Reach (A)	Height (B)	Mast Rotation Range	# of Users	SRL Maximum Arresting Force
M200	12,668 lb. (5,746 kg)	5,000 lb. (2,268 kg)	15 ft. (4.6 m) Single User Models 12 ft. (3.7 m) Dual User Models	Up to 30 ft. (9.1 m)	360° for all bases	1 or 2 depending on model	1,350 lb. (6 kN)

No-Base Systems

- Attach to supporting, fixed structure (e.g. on I-Beam) on the job site.
- Mounting clamps, plates and hardware included with systems.
- System rotates 180 degrees and locks every 7.5 degrees.
- Installed rail with trolley.

Boom height	Offset	# of Users	Part #
TBD by end user	20' (6.1 m)	1	8530433



Model shown
8530433

3M™ DBI-SALA® Counterweighted System

Create an overhead anchor point for multiple workers with ease. The Counterweighted System is a portable solution designed for counterbalancing by concrete or other means, allowing for close positioning to the work surface without obstructing the equipment being accessed. These systems are ANSI and OSHA compliant.

Counterweighted Systems

- Provide effective/economical means of anchoring overhead.
- Includes systems with and without the concrete counterweight on base of unit.
- Ideal in areas with no overhead obstructions and door height restrictions.
- System includes one rail with two trolleys.
- System includes heavy-duty leveling jacks and tag line assist.

Anchor height	Rail width	Offset	Weighted	# of Users	Part #
22' (6.7 m)	32' (9.8 m)	8' (2.4 m)	not included	2	8517760
	32' (9.8 m)	8' (2.4 m)	included	2	8517761
22' (6.7 m)	42' (12.8 m)	8' (2.4 m)	not included	2	8517762
	42' (12.8 m)	8' (2.4 m)	included	2	8517763

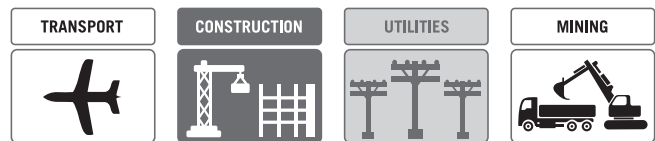

Model shown
8517760

Flexiguard™ Solutions

3M™ DBI-SALA® C-Frame System

A versatile fall arrest solution for working at height, the C-Frame System is designed to be moved manually or with the use of a tow bar and service vehicle. It requires some clearance under the equipment being accessed to accommodate outrigger support legs. These systems are ANSI, OSHA and CE compliant.

Adjustable Height Systems

- Adjustable by manually cranking winch.
- Most often used in areas with no overhead obstructions or door height restrictions.
- System includes heavy-duty leveling jacks.
- Each system includes one rail with two trolleys.

Anchor height	Rail width	Wheels	# of Users	Part #
12.5' - 19' (3.8 m - 5.85 m)	10' (3 m)	16" (0.4 m) Pneumatic	2	8517701
	20' (6.1 m)	16" (0.4 m) Pneumatic	2	8517705
17.5' - 28.75' (5.3 m - 8.8 m)	15' (4.6 m)	16" (0.4 m) Pneumatic	2	8517707
	20' (6.1 m)	16" (0.4 m) Pneumatic	2	8517709

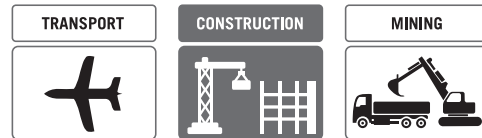

Model shown
8517709

3M™ DBI-SALA® A-Frame System

The A-Frame System provides a secure anchor point on portable structures to give workers increased coverage and protection. Depending on the configuration, this system has the capacity to provide fall protection for up to two workers and can be easily moved from one job site to the next—providing safe and reliable fall protection where you need it. These systems are ANSI, OSHA and CE compliant.

Fixed Height Systems

- Provide effective/economical means of anchoring overhead.
- Each system contains a single rail rated for two users.
- Ideal in areas with no overhead obstructions or door height restrictions.
- System includes heavy-duty leveling jacks.

Anchor height	Rail width	Wheels	# of Users	Part #
15' (4.6 m)	15' (4.6 m)	16" (0.4 m) Caster	2	8517790
	20' (6.1 m)	16" (0.4 m) Caster	2	8517791
	30' (9.1 m)	16" (0.4 m) Caster	2	8517792
20' (6.1 m)	15' (4.6 m)	16" (0.4 m) Caster	2	8517793
	20' (6.1 m)	16" (0.4 m) Caster	2	8517794
	30' (9.1 m)	16" (0.4 m) Caster	2	8517795
30' (9.1 m)	15' (4.6 m)	16" (0.4 m) Caster	2	8517796
	20' (6.1 m)	16" (0.4 m) Caster	2	8517797
	30' (9.1 m)	16" (0.4 m) Caster	2	8517798

Adjustable Height Systems

- Can be adjusted using overhead crane, forklift or powered systems.
- Each system contains two rails for bypassing trolleys.
- Ideal in areas with overhead obstructions and door height limitations where lowering the overall height of the A-Frame is a requirement.
- System includes heavy-duty leveling jacks.

Anchor height	Rail width	Wheels	# of Users	Part #
16' - 22.5' (4.9 m - 6.9 m)	20' (6.1 m)	16" (0.4 m) Pneumatic	2	8517780
	30' (9.1 m)	16" (0.4 m) Pneumatic	2	8517781

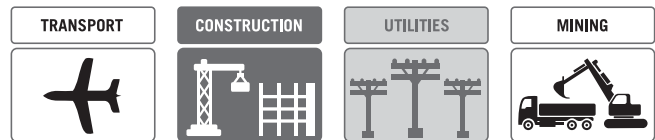

Flexiguard™ Solutions

3M™ DBI-SALA® Freestanding Ladder System

Easy access. 100% fall protection from the ground up. Achieve both for up to two users for the duration of the work with our Freestanding Ladder System. System configurations include guardrails and the use of multiple SRLs. These models are ANSI, OSHA and CE compliant.

Adjustable Height Systems

- Manual height adjustment via winch assembly.
- Multiple height adjustment ranges available.
- All systems include a fall arrest bar for accessing ladder.
- System includes heavy-duty leveling jacks.

Platform height	System type	Wheels	# of Users	Part #
10.75' - 15.5' (3.3 m - 4.7 m)	Portable ladder	16" (0.4 m) Pneumatic	2	8517715
14.5' - 23' (4.4 m - 7.0 m)	Portable ladder	16" (0.4 m) Pneumatic	2	8517717
18.5' - 31' (5.6 m - 9.4 m)	Portable ladder	16" (0.4 m) Pneumatic	2	8517719



TRANSPORT



Model shown
8517715

3M™ DBI-SALA® Supported Ladder System

Provide for safe access and maintenance of transportation vehicles across a wide variety of different applications and environments with our portable Supported Ladder System.

This unique solution offers the best in passive and active fall protection. The work platform is fully enclosed by guardrails for superior passive fall protection and easily accessible through two spring-loaded swing gates. You can also access the working surface of the vehicle through one spring-loaded gate while tied off to the active fall arrest rail. This system is ANSI and OSHA compliant.

Supported Ladder System

- Heavy-duty steel base design with an aluminum platform and fall arrest rail.
- Work platform is covered in a non-slip material.
- System equipped with two heavy-duty stabilizing jacks and two retracting outriggers that can be set without having to go beneath the work surface.



Platform height	Platform length	Platform width	Rail length	Wheels	# of Users	Part #
9' (2.7 m)	9' (2.7 m)	3' (0.9 m)	12' (3.7 m)	8" (0.2 m) Urethane	1	8530397



Flexiguard™ Solutions

3M™ DBI-SALA® Box Frame

Conveniently secure a fall arrest rigid rail in areas with limited space or inadequate overhead structure. Our Box Frame Systems are built to accommodate a specific area or piece of equipment and can be designed as permanent or portable frames, allowing for easy relocation. These systems are ANSI and OSHA compliant.

Fixed Height Systems

- Provide effective/economical means of anchoring overhead.
- Ideal in areas with no overhead obstructions or door height restrictions.

Anchor height	Width	Rail length	Wheels	# of Users	Part #
14' (4.3 m)	14' (4.3 m)	Dual rail 15-1/2' (4.7 m) each	16" (0.4 m) Pneumatic	2	8530345
30' (9.1 m)	20' (6.1 m)	Dual rail 32' (9.8 m) each	16" (0.4 m) Pneumatic	2	8530427

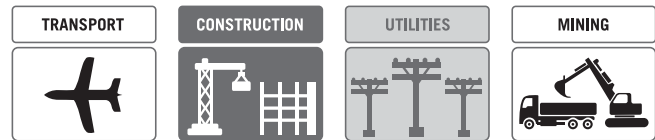

Adjustable Height System

- Adjustable using overhead crane, forklift or powered systems.
- Pin height selection system.
- Ideal in areas with overhead obstructions and door height limitations.

Height	Width	Length	Wheels	# of Users	Part #
12' - 18' (3.7 m - 5.5 m)	12' (3.7 m)	Single rail 20' (6.1 m)	12" (0.3 m) Rubber	2	8530288

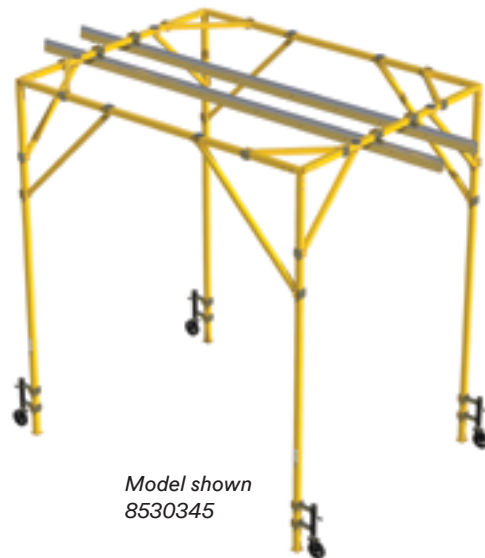

Model shown
8530345





3M™ DBI-SALA® Trailer and Hitch-Mounted Anchor Systems

One simple solution. Endless versatility. Our Trailer and Hitch-Mounted Systems are DOT-rated portable systems that can be attached to a service vehicle hitch receiver for transport to a job site. They provide a standalone solution, leveraging an integrated counterweight or easy attachment to a truck or service vehicle with minimal setup required before use. These systems incorporate overhead anchorage points up to 22' (6.7 m) for a maximum of two users, and are OSHA and ANSI compliant.

Fixed Height Systems

- Trailer and Hitch mounted solutions are DOT rated to maximize portability and versatility to and from job site.
- System quickly raises and lowers with integrated winch and handle.
- System includes heavy-duty stabilizing jacks.

Anchor height	Width	# of Users	Part #
21-1/2' (6.6 m)	7' (2.1 m)	2	8530690

TRANSPORT	CONSTRUCTION	UTILITIES	MINING
			

Accessory	Part #
Drive Clutch Assembly	8548000
Job Box	8530678
Outrigger Pads	8548050



Model shown
8530690
Attachment
not included



Model shown
8548000



Model shown
8548050



Model shown
8530678



Fall Protection Configurator

Introducing a tool to help you visualize large, complex Fall Protection equipment on your worksite before you purchase! Download our new 3M™ Fall Protection Configurator today.

Now you can easily configure and virtually place 3M™ Fall Protection solutions onto your worksite.

Our new configurator takes 'try before you buy' to a new level. Take photos and share with others to spec-in a solution that will help keep your workers safe. Compatible on Apple™ devices and Android™ devices.



Horizontal Systems

Horizontal Systems



Horizontal lifeline systems that deliver mobility and fall protection for at height workers.

3M is proud to engineer a wide variety of horizontal lifeline (HLL) systems to maximize mobility, productivity and fall protection for every worker – no matter what the job calls for. These safety systems are used to protect workers operating in the horizontal plane who may not have continuous access to suitable lifeline anchorage points.

How to choose a horizontal lifeline system

An HLL may appear to be a basic line strung between two anchors but it is much more than that. It is critical to choose a horizontal system that has been precision engineered and rigorously tested to meet industry standards. Other important considerations when selecting a system include:

Anchorage structure

The structure your system must attach to, such as an I-beam, rebar stud, concrete column or roof can dictate the type of specialized system required.

Portable or permanent

Temporary jobs require lightweight and easy-to-use portable systems that can be moved from one location to another. If a hazardous work area is accessed often, such as a rooftop, a permanent solution like Uniline™ may be a better choice.

Clearance requirements

The distance between the work area and the next level or obstruction is often called “fall clearance,” and this is a critical factor when choosing your system. Anchorage height, type of lifeline and length are just a couple of factors that will affect the required clearance needed.

Lifeline type

Synthetic lines are extremely lightweight and compact, while galvanized or stainless steel options offer enhanced corrosion and abrasion resistance.

Number of users

Always consider the number of workers required to get the job done and choose a system that can accommodate those personnel safely.



Horizontal Systems

3M™ DBI-SALA® SecuraSpan

Horizontal Lifeline (HLL) Systems

Extremely lightweight and portable, these systems incorporate a modular, multi-base design that accommodates a wide range of steel and concrete beams.

- Interchangeable stanchions are ideal for both steel and concrete applications.
- Extremely lightweight and portable for fast and easy setup and use.
- Single and multi-span options available for jobsite customization.
- Pass-through bracket design provides 100% continuous protection.
- Integrated Zorbit™ Energy Absorber limits forces on structure.
- Capacity of two workers per span, up to six workers for multi-span system.
- Durable and corrosion-resistant construction.
- Inquire about perpendicular applications.

Steel I-Beam applications

- Single clamp and wing nut design.
- All adjustments made from top of beam.
- Fits flanges 6" - 12" wide, 2 - ¼" thick (15.2 cm - 30.5 cm, 5.7 cm).
- Optional bases for 18", 24" and 36" widths (45.7 cm, 60.9 cm and 91.4 cm).

Concrete rebar and shear stud applications

- Simply attach with torque wrench.
- Simple chain tie-back connection.
- Fits ½" - 1" diameter (1.3 cm - 2.5 cm) (#4 - #8 rebar) and 4" - 12" (10 cm - 30.5 cm) centre to centre.

7400460

3M™ DBI-SALA® SecuraSpan

I-Beam Horizontal Lifeline System

Complete single span system includes two stanchions (7400047) and cable assembly with tensioner and Zorbit™ Energy Absorber, 60' (18.3 m).

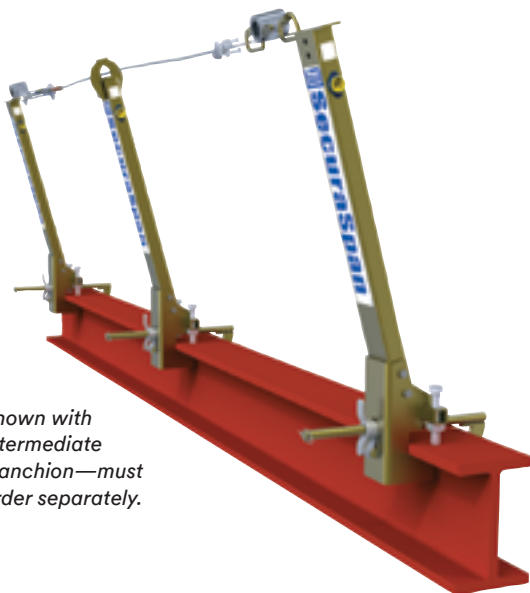

Shown with intermediate stanchion—must order separately.

Description	Size	Part #
3M™ DBI-SALA® SecuraSpan I-Beam HLL System	20' (6.1 m)	7400420
3M™ DBI-SALA® SecuraSpan I-Beam HLL System	30' (9.1 m)	7400430
3M™ DBI-SALA® SecuraSpan I-Beam HLL System	40' (12.2 m)	7400440
3M™ DBI-SALA® SecuraSpan I-Beam HLL System	50' (15.2 m)	7400450

7400008

3M™ DBI-SALA® SecuraSpan

I-Beam HLL Stanchion Intermediate Bracket



Description	Size	Part #
3M™ DBI-SALA® SecuraSpan™ I-Beam HLL Stanchion Intermediate Bracket	Various lengths and individual components are available to completely customize your system	7400008v

7400660

3M™ DBI-SALA® SecuraSpan

Rebar/Shear Stud Horizontal Lifeline System

Complete single span system includes two Stanchions (7400215) and cable assembly with tensioner and Zorbit™ Energy Absorber, 60' (18.3 m).

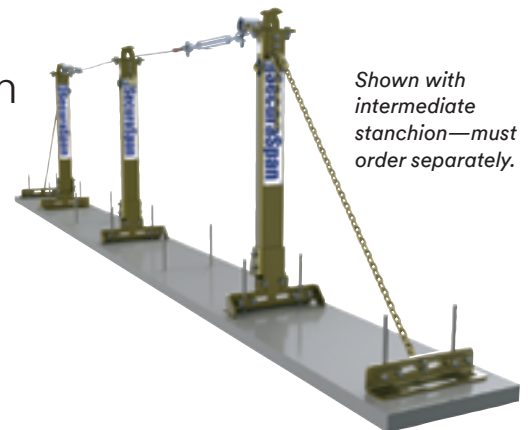

Shown with intermediate stanchion—must order separately.

Description	Size	Part #
3M™ DBI-SALA® SecuraSpan Rebar/Shear Stud HLL System	20' (6.1 m)	7400620
3M™ DBI-SALA® SecuraSpan Rebar/Shear Stud HLL System	30' (9.1 m)	7400630
3M™ DBI-SALA® SecuraSpan Rebar/Shear Stud HLL System	40' (12.2 m)	7400640
3M™ DBI-SALA® SecuraSpan Rebar/Shear Stud HLL System	50' (15.2 m)	7400650

Concrete Loop Rebar Applications

An easy-to-install system for pre-stressed concrete beams, this attaches directly to the loop rebar. With integrated “bypass” brackets, the system can be configured to run indefinitely.

- Simple hook and loop with wing nut.
- Fits ½" - 4-½" dia. (1.3 cm - 11.4 cm) (#4 - #12 rebar).
- Adjusts to fit 3-½" - 8" (8.9 cm - 20.3 cm) tall loop with 3" (7.6 cm) or greater spacing.

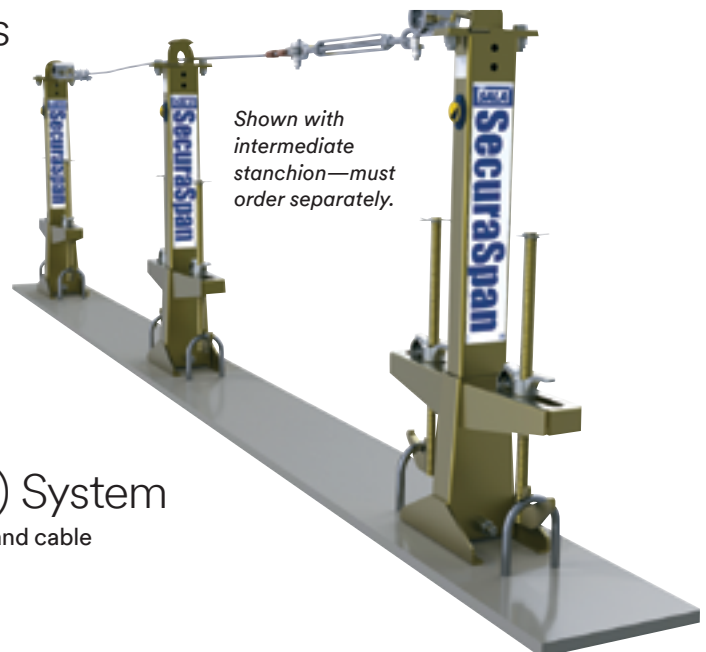

Shown with intermediate stanchion—must order separately.

7400360

3M™ DBI-SALA® SecuraSpan

Loop Rebar Horizontal Lifeline (HLL) System

Complete single span system includes two Stanchions (7400047) and cable assembly with tensioner and Zorbit™ Energy Absorber, 60' (18.3 m).

Horizontal Systems

3M™ DBI-SALA® SecuraSpan System Components

I-Beam System Components

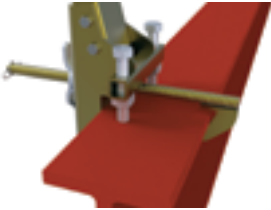

Description	Fit	Part #
3M™ DBI-SALA® SecuraSpan Stanchion with I-Beam Base	6" - 12" (15.2 cm - 30.5 cm)	7400047
3M™ DBI-SALA® SecuraSpan Stanchion with I-Beam Base	12" - 18" (30.5 cm - 45.7 cm)	7400055
3M™ DBI-SALA® SecuraSpan Stanchion with I-Beam Base	18" - 24" (45.7 cm - 61 cm)	7400056
3M™ DBI-SALA® SecuraSpan Stanchion with I-Beam Base	24" - 36" (61 cm - 91.4 cm)	7400057
3M™ DBI-SALA® I-Beam Stanchion	2-¼" (5.7 cm) thick, 6" - 12" (15.2 cm - 30.5 cm) wide	7400001
3M™ DBI-SALA® I-Beam Base Only	6" - 12" (15.2 cm - 30.5 cm)	7400052
3M™ DBI-SALA® SecuraSpan Stanchion with I-beam base for heavy flange	6" - 48" (15.2 cm - 122 cm)	7400073

Perpendicular I-Beam System Components



Description	Fit	Part #
3M™ DBI-SALA® Stanchion with Perpendicular I-Beam Base: No tie back	8"-14" (20.32 cm - 35.56 cm)	7400087
3M™ DBI-SALA® Perpendicular I-Beam Base Only	8"-14" (20.32 cm - 35.56 cm)	7400086
3M™ DBI-SALA® Perpendicular Pass-Through Kit	-	7400089

See product instruction manual for complete clearance information.

Lifeline options for all systems — Cable assembly with turnbuckle and Zorbit, lengths available in 10' (3 m) increments. Cable assemblies over 60' (18.3 m) include two Zorbit™ Devices.

Rebar / Shear Stud Base System Components

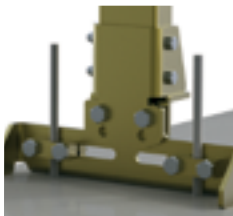

Description	Part #
3M™ DBI-SALA® Stanchion with Rebar/Shear Stud Base: Pass-through and end anchor brackets	7400215
3M™ DBI-SALA® Tie-Back and Chain Assembly	7400214
3M™ DBI-SALA® End-Anchor Retro-Fit Kit: With Rebar/Shear Stud Base, tie-back assembly, end anchor and Pass-Through Bracket	7400053
3M™ DBI-SALA® Sub Stanchion for Intermediate Retro-Fit Kit: with Rebar/Shear Stud Base and Pass-Through Bracket	7400054

Loop System Components



Description	Fit	Part #
3M™ DBI-SALA® Stanchion with loop rebar base and pass-through bracket	–	7400045

3M™ DBI-SALA® SecuraSpan

Pour-in-Place Horizontal Lifeline Systems

The SecuraSpan Pour-in-Place System installs to column tops, providing an overhead tie-off point during the decking process. The stanchion slides into the embedded pour-in-place sleeve and does not require “tie-back” for fast installation.

- Lightweight and portable for fast and easy setup and use.
- Single and multi-span options with unlimited length for jobsite customization.
- Pass-through design provides 100% continuous protection.
- Integrated Zorbit™ Energy Absorber limits forces on worker and structure.
- Capacity of two workers per span, up to six workers for multi-span system.
- Durable and corrosion-resistant construction.

Complete system includes two Stanchions (7400203), and cable assembly with tensioner and Zorbit™ Energy Absorber.



20' (6.1 m)	30' (9.1 m)	40' (12.2 m)	50' (15.2 m)	60' (18.3 m)
7400220	7400230	7400240	7400250	7400260



See product instruction manual for complete clearance information.

Horizontal Systems

Pour-in-Place Accessories

Description	Image	Part #
3M™ DBI-SALA® SecuraSpan Stanchion Assembly: 7-1/2' (2.3 m) tall.	-	7400203
3M™ DBI-SALA® SecuraSpan Intermediate Bracket: for pour-in-place stanchion.	-	7400200
3M™ DBI-SALA® SecuraSpan Concrete Sleeve: for pour-in-place stanchion.	-	7400201
3M™ DBI-SALA® SecuraSpan Clamp-On Vertical Base: Zinc-plated steel construction, clamps to existing vertical steel and concrete structures.		7400211
3M™ DBI-SALA® SecuraSpan Bolt-On Vertical Base: zinc-plated steel construction, bolts to vertical steel and concrete structures. 7400225 Stainless steel version		7400218
3M™ DBI-SALA® Weld-On Vertical Base: Steel C-channel construction, welds to vertical steel structures.		7400222
3M™ DBI-SALA® Bolt-On Floor Base: Zinc-plated steel construction. Bolts to steel and concrete horizontal surfaces.		8530267

3M™ DBI-SALA® Sayflin

Cable Horizontal Lifeline (HLL) Systems

The Sayflin Cable System is highly portable and ideal for situations where welding, sparks or harsh environments are present, or where minimal clearance exists. Complete system includes cable lifeline assembly with wedge grip termination, tensioner and Zorbit™ Energy Absorber.



See product instruction manual for complete clearance information.

- Durable all-metal system can be left in place for long periods of time.
- Portable system can be reused over and over again.
- Cable lifeline with tensioner and energy absorber.
- Use with any 5,000 lb. (22 kN) anchorage devices.
- Capacity of two workers.
- 20' - 100' lengths available. (6.1 m - 30.5 m)

Sayflin Cable HLL Systems

20' (6.1 m)	30' (9.1 m)	40' (12.2 m)	50' (15.2 m)	60' (18.3 m)	70' (21.3 m)	80' (24.4 m)	90' (27.4 m)	100' (30.5 m)
7602020	7602030	7602040	7602050	7602060	7602070	7602080	7602090	7602100

3M™ DBI-SALA® Sayflin

Synthetic Horizontal Lifeline System

The synthetic 3M™ DBI-SALA® Sayflin Synthetic Horizontal Lifeline System is extremely lightweight and easy to install. Engineered with attention to quality and detail, the 3M™ DBI-SALA® Sayflin Systems will work alongside you during maintenance, bridgework, construction and general industry applications with absolute safety and reliability. A horizontal lifeline may appear to be a basic line strung between two anchors, but it is not. These systems are used to protect workers operating in the horizontal plane who may not have continuous access to suitable anchorage points.



Sayflin Synthetic HLL Systems

20' (6.1 m)	30' (9.1 m)	40' (12.2 m)	50' (15.2 m)	60' (18.3 m)	70' (21.3 m)	80' (24.4 m)	90' (27.4 m)	100' (30.5 m)
7600701	7600702	7600703	7600704	7600705	7600706	7600707	7600708	7600709

Horizontal Systems

Rebar / Shear Stud Base System Components

7605063

3M™ DBI-SALA® EZ-Line™

Retractable Horizontal Lifeline (HLL) System

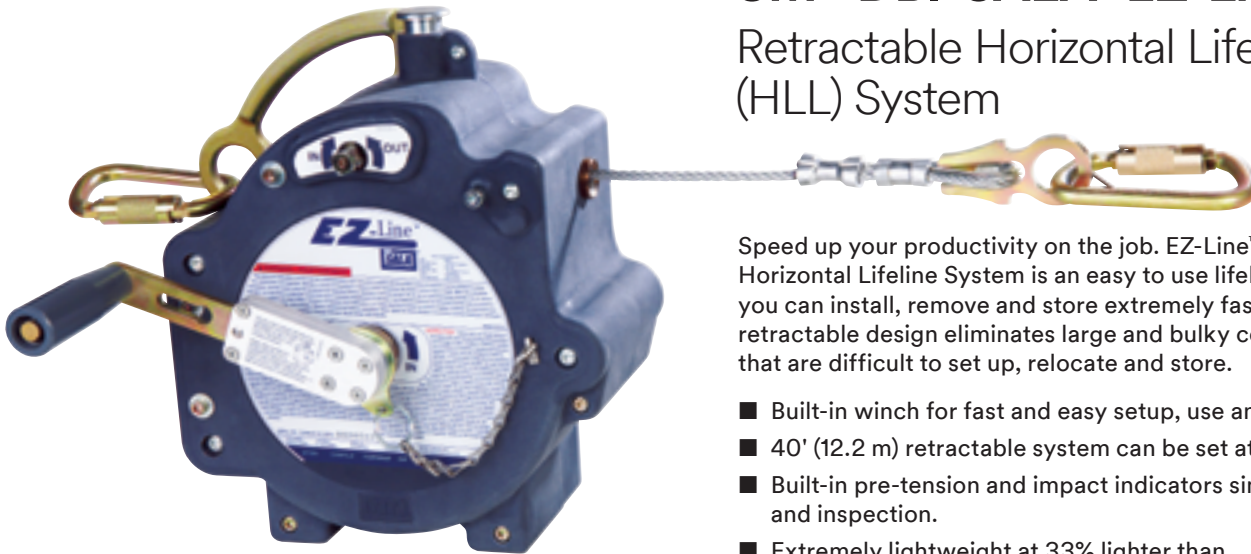

See product instruction manual for complete clearance information.

Speed up your productivity on the job. EZ-Line™ Retractable Horizontal Lifeline System is an easy to use lifeline system that you can install, remove and store extremely fast. Its innovative retractable design eliminates large and bulky coils of cable that are difficult to set up, relocate and store.

- Built-in winch for fast and easy setup, use and dismantling.
- 40' (12.2 m) retractable system can be set at any length.
- Built-in pre-tension and impact indicators simplify setup and inspection.
- Extremely lightweight at 33% lighter than conventional systems.
- Two worker capacity.

Description	Part #
3M™ DBI-SALA® Replacement EZ-Line™ Handle Assembly	7600002

3M™ DBI-SALA®

Zorbit™ Kits

Description	Part #
3M™ DBI-SALA® Zorbit™ Energy Absorber Only	7401013
3M™ DBI-SALA® Zorbit™ Energy Absorber: with three shackles, bolts, nuts.	7401031
3M™ DBI-SALA® Zorbit™ Energy Absorber: with three shackles, bolts, nuts, turnbuckle.	7401032
3M™ DBI-SALA® Zorbit™ Energy Absorber: with three shackles, bolts, nuts, turnbuckle, thimbles, cable clips.	7401033
3M™ DBI-SALA® Zorbit™ Energy Absorber: with three shackles, bolts, nuts, turnbuckle, thimbles, cable clips with wedge grip, two O-rings.	7600580



Horizontal Lifeline Components

- Allows use of standard 5,000 lb. (22 kN) rated anchors.
- Lightweight and compact for easy setup and use.
- Simple design makes integration into system fast and easy.



Vertical Systems

Vertical Systems

Security and confidence at height.



3M™ DBI-SALA® Vertical Systems are designed to offer added security, climbing mobility and productivity when you climb with our gear.

Vertical fall protection systems allow workers to move up and down the entire height of the lifeline rather than having to disconnect and find new tie-off points along the way.

Some important considerations when selecting a system include:

Portable or permanent.

Temporary jobs require lightweight and easy-to-use portable systems with synthetic lifelines that can be moved from one location to another. For structures that are accessed often, a permanent solution is a better choice.

Mobile or fixed.

Mobile rope grab or ladder sleeve designs automatically follow the user for easy operation. Manually adjusted devices allow the user to fix the unit in place for positioning or restraint applications.

Vertical Systems

3M™ DBI-SALA® Lad-Saf™ Flexible Cable Vertical Safety Systems

Adding or upgrading your vertical safety systems just got easier. The new generation of Lad-Saf™ Systems are re-engineered to simplify and speed up the installation process. With up to 72% fewer loose components* than some of our previous models, these lightweight systems are streamlined for easy installation and maintenance on a variety of structures—such as fixed ladders and telecommunication towers.

They have also been designed to meet the requirements of the new ANSI Z359.16 standard when used with our Lad-Saf™ X2 or X3 Sleeve, helping you to stay in compliance with the current fall protection standards.

6116632
Rung, 2 User,
Stainless Steel

6116631
Rung, 2 User,
Galvanized Steel

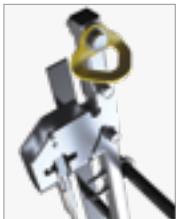

Convenient

Integrated fall arrest-rated anchor point.

Fast

Installation is easy with fewer loose parts and more robust cable tensioning and termination as compared to our previous systems.

New Pre-Swaged Cable Termination

Durable, high-strength steel construction that allows for easy installation and maintenance-free longevity.

Flexible

Mounting brackets can be used on a variety of fixed ladder styles that may consist of different rung spacings and shapes.

Light

Total system weighs less than our previous 2- and 4-user systems.

Simple

Most configurations use fewer than 13 separate components—up to 72% less than some of our previous models.

Compatible

Designed for use with your Lad-Saf™ X3 Detachable Cable Sleeve (6160054). Also compatible with Lad-Saf X2 Detachable Cable Sleeve (6160030).

**On specific models.*



Previous
Generation
Cable



Lad-Saf™ X3

Introducing

3M™ SecureFit™ Safety Helmet X5000 Series

Achieve comfort without
compromise while you climb.



3M™ DBI-SALA® Lad-Saf™ Flexible Cable Vertical Safety Systems

6116633

Rung, 4 User,
Galvanized Steel



6116634

Monopole, 4 User,
Galvanized Steel



6116638

Monopole, 4 User,
Stainless Steel

6116618

Telescoping Extension,
4 User, Galvanized Steel

*Ideal to provide access to rooftops
through a roof hatch.*



6116636

Climb Extension,
2 User,
Galvanized Steel

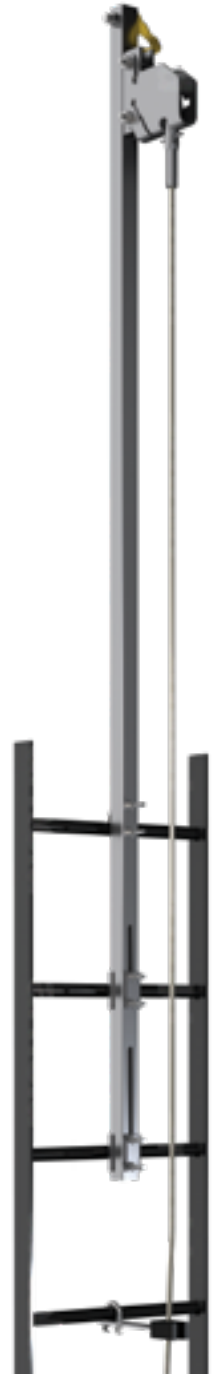

Vertical Systems

3M™ DBI-SALA® Lad-Saf™

Custom Configured Systems

Choose from each of the following categories:

Top and Bottom Bracket System (both brackets included)

Application	User	Material	Part #
Rung	2 User	Galvanized Steel	6116631
Rung	2 User	Stainless Steel	6116632
Rung	4 User	Galvanized Steel	6116633
Wood Pole	2 User	Galvanized Steel	6116635
Monopole	4 User	Galvanized Steel	6116634
Monopole	4 User	Stainless Steel	6116638
Climb Extension	2 User	Galvanized Steel	6116636
Telescoping Extension	4 User	Galvanized Steel	6116618

Pre-swaged cable at desired length

First 4 numbers in SKU represent the cable type, last 3 numbers represent cable length in feet.

Part #	6104XXX	6105XXX	6106XXX	6107XXX
Diameter	3/8 in. (9.5 mm)	3/8 in. (9.5 mm)	3/8 in. (9.5 mm)	3/8 in. (9.5 mm)
Strand	1 x 7	1 x 7	7 x 19	7 x 19
Steel	Galvanized	Stainless	Galvanized	Stainless
Preformed	Left, Regular Lay	Left, Regular Lay	Right, Regular Lay	Right, Regular Lay
Compliance	RR-W-410	RR-W-410	RR-W-410	RR-W-410
Breaking strength	15,400 lb. (6,985.32 kg) minimum	18,000 lb. (8,164.66 kg) minimum	14,400 lb. (6,531.73 kg) minimum	12,000 lb. (5,443.1 kg) minimum

Lifeline cable offered in:

- 10 ft. – 100 ft. (3.048 m – 30.48 m) in 5 ft. (1.524 m) increments
- 100 ft. – 200 ft. (30.48 m – 60.96 m) in 10 ft. (3.048 m) increments
- Over 200 ft. (60.96 m) in 20 ft. (6.096 m) increments



Cable guides as needed (recommended every 20-40 feet)

Application(s)	Type	Material	Part #
Ladder	Straight Guide	Galvanized Steel	6100400
Ladder	Straight Guide	Stainless Steel	6100457
Ladder	Straight Guide	Galvanized Steel	6100530
Telescoping and Extension	Straight Guide	Stainless Steel	6100401
Monopole	L Guide	Galvanized Steel	6100515
Wood Pole	Straight Guide	Stainless Steel	6100140

6100400



Additional cable guides available. Contact your 3M Fall Protection Sales Representative for more information.

3M™ DBI-SALA® Lad-Saf™

Complete Systems

Ordering a complete system is now even easier. We offer our most popular systems and lengths including all bracketry, cable, and guides—all in one single SKU.

2-User Ladder System and Cable

Cable Length	20 ft. (6.09 m)	30 ft. (9.14 m)	40 ft. (12.19 m)	50 ft. (15.24 m)	60 ft. (18.28 m)	70 ft. (21.33 m)	80 ft. (24.38 m)	90 ft. (27.43 m)	100 ft. (30.48 m)
Guides Included	0	1	1	1	2	2	2	3	3
Galvanized Steel: <ul style="list-style-type: none"> 6116631: Rung, 2-User 6104XXX: 1 × 7 Swaged Cable, 3/8 in. 6100400: Cable Guide for fixed ladder (1 per 30 ft.) 	6118020	6118030	6118040	6118050	6118060	6118070	6118080	6118090	6118100
Stainless Steel: <ul style="list-style-type: none"> 6116632: Rung, 2-User 6105XXX: 1 × 7 Swaged Cable, 3/8 in. 6100457: Cable Guide for fixed ladder (1 per 30 ft.) 	6119020	6119030	6119040	6119050	6119060	6119070	6119080	6119090	6119100



5901980

Ladder Gate

Designed to help protect you from the dangers (and liability) of unauthorized ladder access.

- Fits ladder widths up to 20 in. (50.8 cm). Mounting hardware included
- Aluminum construction 8 ft. (2.4 m) height x 36 in. (91.4 cm) width

Vertical Systems

3M™ DBI-SALA® Fixed Ladder SRL Anchors

Ideal fall protection solution for step-through style fixed ladder systems.

- Easy to transport: under 30 lb. for ease of transport and installation
- Simple setup: installs on the ladder in 5 minutes or less
- Versatile installation: the ladder anchor can be mounted to the front or behind the ladder with left, right or centre alignments
- Compatible with your existing fall protection harness: unlike a fixed cable system, this solution doesn't require a front D-ring, which can help reduce overall implementation costs
- Designed for durability: available in galvanized or stainless steel
- Meets 29 CFR OSHA 1910 Walking Working Surfaces Section 1910.27

Description	Length	Material	Part #
3M™ DBI-SALA® Fixed Ladder SRL Anchor	4 ft	Galvanized	6100562
3M™ DBI-SALA® Fixed Ladder SRL Anchor	4 ft	Stainless Steel	6100563
3M™ DBI-SALA® Fixed Ladder SRL Anchor	6 ft	Galvanized	6100564
3M™ DBI-SALA® Fixed Ladder SRL Anchor	6 ft	Stainless Steel	6100565
3M™ DBI-SALA® Ladder Anchor Tagline			6100566

Create a complete system with a
3M™ DBI-SALA® Self-Retracting Lifeline.

Our Sealed-Blok design includes environmentally sealed dynamic components making it a durable solution.



3M™ DBI-SALA® SSB Systems

SSB Systems support workers' motions and provides fall protection while climbing tall ladders and towers. Great for great for drilling rigs and derricks.

Added safety.

Counterweight includes a runaway brake as a backup safety measure.

Ultimate flexibility.

No limit to length of system.

Enhanced durability.

Block pulley features rugged aluminum housing and system is galvanized for corrosion resistance.

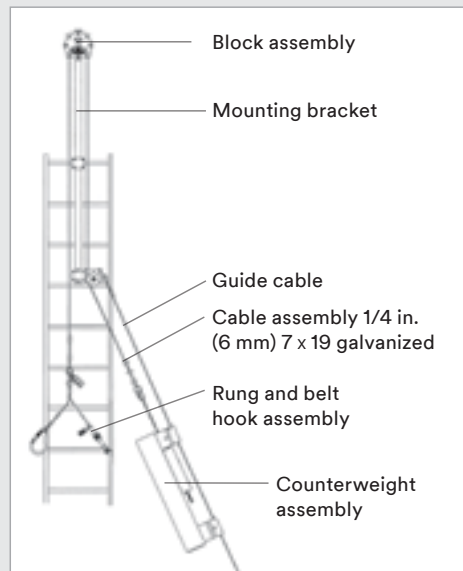
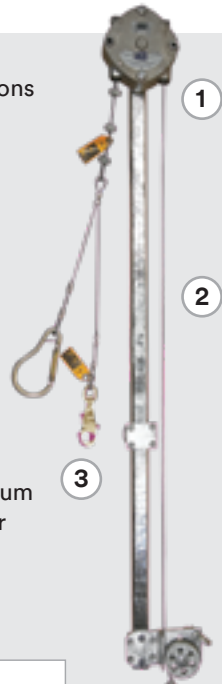

1 3511063

SSB Safety Block

Climb assist main block pulley assembly.

2 3512XXX

Lifeline Assembly

Galvanized 1/4 in. (6.3 cm) 7 × 19 cable assembly with rung and belt hook (last three digits in part number signify length).

3530XXX Stainless Steel Lifeline Assembly

3 3511783

Mounting bracket

Attaches safety block to structure. Fits round rungs up to 3/4 in. (1.9 cm) diameter or square rungs up to 9/16 in. (1.4 cm) per side.

3511785 Mounting bracket, fits round rungs over 3/4 in. (1.9 cm) up to 1-1/2 in. (3.8 cm) diameter or square rungs over 9/16 in. and up to 1-1/2 in. (3.8 cm) per side.

3511645 Rung Belt Assembly

4 3511598

Counterweight Assembly

80 lb. (36.3 kg) counterweight with integrated runaway brake system.

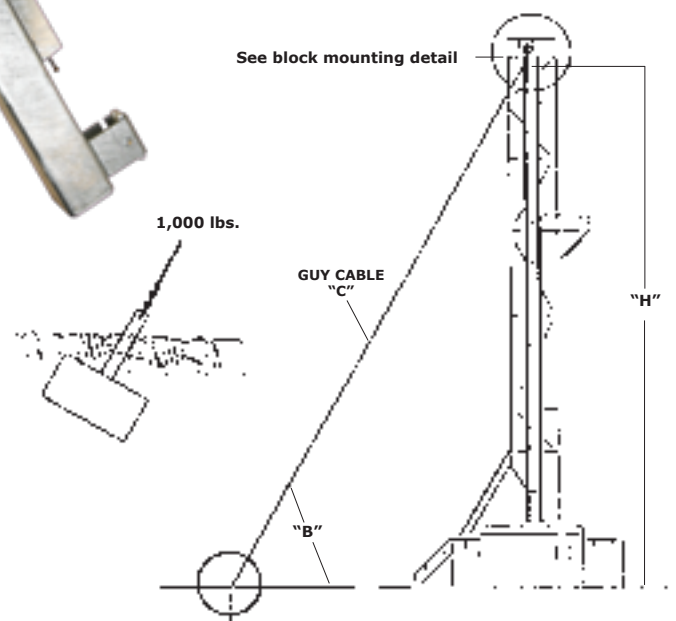

Vertical Systems

3M™ DBI-SALA® Rope Grabs

5000335C

3M™ DBI-SALA® Lad-Saf™ Rope Grab with attached EZ-Stop™ Shock-Absorbing Lanyard x 2.5 ft (0.7 m)

Detachable design can be attached or removed anywhere along lifeline. For use on 3M approved 5/8 in. (16 mm) polyester/polypropylene rope lifeline. Use with 2.5 ft (0.7m) shock-absorbing lanyard.



5000009C

3M™ DBI-SALA® EZ-Stop™ Rope Adjuster (2.5 ft, 0.7 m)

Installs at top or bottom of the lifeline. Durable and lightweight, corrosion resistant construction. For use on 3M approved 5/8 in. (16 mm) rope lifeline. Equipped with RFID.



Rope Lifelines

These Polyester/Polypropylene Blended Rope Lifeline Assemblies feature additional abrasion and UV resistance for added durability, longevity and safety. Various styles and lengths are available to suit any need.

5901583

Counterweight

5.7 lb. (2.6 kg) flexible counterweight keeps lifeline taut. Heavy-duty nylon construction. Built-in web loop for easy attachment to lifeline. Compact and portable design. Equipped with RFID.



Polyester/Polypropylene Blended Rope Lifeline

Hook style	Lifeline diameter (inch/mm)	25 ft. (8 m) lifeline	50 ft. (15 m) lifeline	75 ft. (22 m) lifeline	100 ft. (30 m) lifeline	150 ft. (46 m) lifeline
Snap hook at one end	5/8 in. (15.9 mm)		1202794C	1202821C	1202844C	1202879C
Snap hook at both ends	5/8 in. (15.9 mm)	1202740C	1202790C	1202823C	1202842C	1202878C

Custom sizes available.



Rescue and Descent

Rescue and Descent

Choosing rescue and descent systems.

The type of job site, anchor location, working load and limit, and ease of use are all important factors in choosing the proper rescue and descent system.

A single rescue and descent system cannot efficiently handle every scenario – a rescue and descent system that performs well for one application might not be right for a different application. This is why we offer rescue and descent systems for multiple applications and multiple skill levels.



3M™ DBI-SALA® Rollgliss™

R550 Rescue and Descent Device

Keep rescues simple with the Rollgliss™ R550 Rescue Unit. It's among the lightest, most compact, and easy-to-use designs in its class. It offers the choice of rescue, evacuation, or the versatility of assisted rescue with lifting capabilities. When every second counts, count on the R550.



Super tough nylon makes the R550 rescue wheel lightweight and durable. Its ergonomic design gives the user a better grip and more control.



1 Drill adapter

Provides a mechanical option to raise a victim. Compatible with most cordless hand drills.

2 Cast aluminum housing

Lightweight and extremely durable cast housing.

3 Bi-directional hub

Rope descends from either side which brings one hook up as the other goes down, allowing for immediate use after each descent.

4 Anchorage

Used to anchor the device with either a carabiner or sling.

5 Integrated rope ears

Allows for greater descent speed control in assisted rescues.

6 Dual brakes

Automatic descent with added security, safety and peace of mind.

7 Durable rope

3/8" (9.5 mm) static kernmantle Rope. NFPA - L rated for durability.

8 Lifeline hook

Patented self-locking snap hook is industry preferred and compatible with our Remote Anchoring System for remote rescue capabilities.

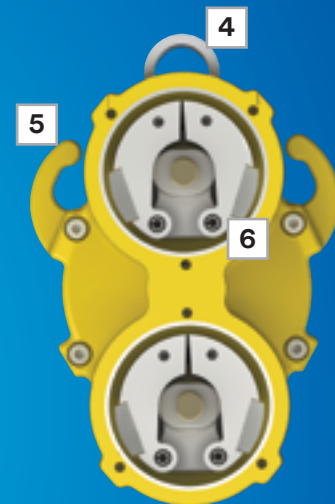

Extremely compact

The R550 is the lightest, most compact unit in its class.

Multiple length options

Lengths between 50' (15 m) and 500' (152 m). Rope bag included with each model.

Two-person capacity

Can be used from heights up to 1,640' (500 m) for one user at 310 lb (141 kg) or 575' (175 m) for two users totaling 620 lb (282 kg).

Optional Ladder Bracket

Sold separately (3320014).

Rescue and Descent

3M™ DBI-SALA® Rollgliss™ R550 Rescue Units

Includes carabiners (two), 4' (1.2 m) anchor sling and rope bag.

Part #	Length	Weight
3327050	50' (16 m)	11.9 lb (5.4 kg)
3327100	100' (31 m)	13.8 lb (6.2 kg)
3327150	150' (46 m)	15.7 lb (7.1 kg)
3327200	200' (61 m)	17.6 lb (8 kg)
3327275	275' (84 m)	20.5 lb (9.3 kg)
3327300	300' (92 m)	21.4 lb (9.7 kg)
3327325	325' (100 m)	22.4 lb (10.1 kg)
3327350	350' (107 m)	23.8 lb (10.8 kg)
3327400	400' (122 m)	25.7 lb (11.6 kg)
3327450	450' (137 m)	27.6 lb (12.5 kg)
3327500	500' (153 m)	29.5 lb (13.4 kg)



Accessories

Part #	Description
9506162	Rope bag, to 325' rope capacity
3320003	Edge Protector with Carabiner
9504733	Pulley AC202D/0 Rope Grab
3320014	Ladder Bracket
9508289	Humidity Case
2000112	Carabiner, 11/16 in (1.7 cm) gate
2000114	Carabiner, 2-3/16 in (5.5 cm) gate
8900298	Rescue Pole: 4' - 16' (1.2 - 4.9 m) aluminum extension pole, over-sized aluminum connection hook with 2-1/4" gate opening (57.1 mm) and carrying bag

Rollgliss™ R550 Escape Units

Includes two carabiners (two), 4' (1.2 m) anchor sling and rope bag.

Part #	Length	Weight
3325100	100' (31 m)	12.7 lb (5.7 kg)
3325200	200' (61 m)	16.5 lb (7.5 kg)
3325275	275' (84 m)	19.4 lb (8.8 kg)
3325300	300' (92 m)	20.3 lb (9.2 kg)



Rollgliss™ R550 Rescue Units with Case

Includes edge protector, 4' (1.2 m) anchor slings (two), 2.5' (0.7 m) anchor sling, pulley, rope grab, carabiners (three), rope bag, and humidity case.

Part #	Length	Weight
3326100	100' (31 m)	35.3 lb (16 kg)
3326300	300' (92 m)	42.9 lb (19.4 kg)
3326350	350' (107 m)	44.8 lb (20.3 kg)



9508289

Fully sealed case provides 10 year minimum storage life. External humidity indicator allows user to inspect the seal without opening case.

Rescue and Descent

Model shown
3400930C



3M™ DBI-SALA® RSQ

Dual-Mode Descent

Our exclusive RSQ Dual-Mode Descent is a built-in rescue operation feature allowing you to work and rescue with the same equipment. That means a lower cost of ownership without compromising on safety. It includes:

- Standard fall arrest mode
- Automatic descent mode
- Remote/assisted descent activation options
- As featured on Sealed-Blok RSQ and Ultra-Lok™ RSQ Self Retracting Lifelines

Sealed-Blok RSQ Self-Retracting Lifelines

Part #	Description
3400932C	Sealed-Blok RSQ SRL: 50' (15 m) of 3/16" (5 mm) stainless steel wire rope with swivel snap hook, RSQ dual-mode, anchorage carabiner, 4' (1.2 m) cable tie-off adapter
3400889	Sealed-Blok RSQ SRL: 85' (25.5 m) of 3/16" (5 mm) stainless steel wire rope with swivel snap hook, RSQ dual-mode, anchorage carabiner, 4' (1.2 m) cable tie-off adapter

3M™ DBI-SALA® Sealed-Blok RSQ SRL

Assisted Rescue Accessories

Part #	Description	Size
3500201C	Remote Anchoring System Pole with Assisted Rescue Tool	6' - 12' (1.8 m - 3.6 m)
3500202C	Remote Anchoring System Pole with Assisted Rescue Tool	8' - 16' (2.4 m - 4.8 m)
3500200C	Assisted Rescue Tool only (If you already have a System Pole)	-

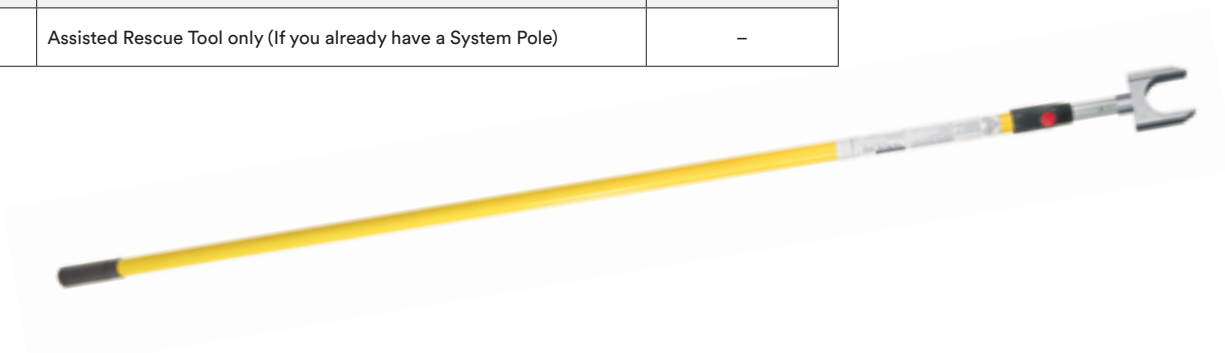

3M™ DBI-SALA® Rollgliss™ R350 Rescue and Positioning Device

The Rollgliss™ R350 System provides efficient hauling, but more importantly, very controlled lowering (a finger and thumb are all that is required to hold a load).

Part #	Description
8902004	Rollgliss™ R350 Rescue System: 50' travel/200' of 3/8" rope (15.25 m/61 m), 3:1 ratio with pulleys, rope control device, anchor strap, carabiner and carrying bag
8902006	Rollgliss™ R350 Rescue System: 100' travel/400' of 3/8" rope (30.5 m/122 m), 3:1 ratio with pulleys, rope control device, anchor strap, carabiner and carrying bag

Other lengths available in 10' (3 m) increments.

Accessories including 2:1, 4:1 and 5:1 pulleys are also available.



Rescue and Descent

3M™ DBI-SALA® Rollgliss™

Descender

Help personnel make a quick, safe escape with the Rollgliss™ Descent Device. Either vertical or sloped descent models are available to provide complete versatility and flexibility for any job site or work environment.

- Simple design for easy installation and use.
- No power source or special skills or tools required.
- Simply connect to harness and step off structure for evacuation.
- Use repeatedly without factory servicing after user inspection.
- Corrosion-resistant construction for maximum durability.
- Wire rope lifeline for added durability in extreme environments.
- Automatic retraction.

Part #	Description
3303000	Rollgliss™ Descender

Descent type	Lifeline material	Speed	115' (35 m)	200' (61 m)	
			Vertical	Galv	Low
			SS	Low	3303002
Sloped	Galv	Low		3303021	



Sloped low speed models also include linkage, guide cable sleeve and suspension bars. Sloped high speed models include linkage, braking trolley and suspension bars.

3M™ DBI-SALA® Rollgliss™

Rescue Positioning Devices (RPD)

Service buildings, bridges and dams with the simple safety of the Rollgliss™ Rescue Positioning Device. Featuring a speed-sensing lock that allows you to manually lock off the device once you reach a work level, it serves both as a rescue system and has features for raising, lowering and positioning during normal work activities. Either the user or a second standby worker can operate it for enhanced versatility.

- Pre-rigged for quick and easy installation and use.
- No special tools, power source or extensive skills needed.
- Built-in brake stops a fall should user lose control.
- Lock-out mechanism allows user to stop/start anywhere.
- 3:1 or 4:1 lifting ratio configurations available.
- Durable, corrosion-resistant construction.



Part #	Description
3602050	Rollgliss™ Rescue Positioning Device: 50' travel/260' of 3/8" rope (15.25 m/79.3 m), 4:1 ratio with pulleys, rope anchor straps, two carabiners and carrying bag
3602100	Rollgliss™ Rescue Positioning Device: 100' travel/510' of 3/8" rope (30.5 m/155.5 m), 4:1 ratio with pulleys, rope anchor straps, two carabiners and carrying bag
3302002	Rescue Sling

3M™ DBI-SALA® Rollgliss™

Sealed Tension Limiter

Unique device attaches to man-riding system in-line between the person and the raising/lowering line to warn operator and limit forces on an entangled worker.

- Limits loading on person to 400 lb (182 kg) to prevent severe injury when entangled.
- High visibility line is easy to see should deployment occur.
- Portable and lightweight for easy transport and quick setup.

Always use a separate back-up fall protection device with this system.

Part #	Description
3601490	Rollgliss™ Sealed Tension Limiter



3M™ DBI-SALA® Rollgliss™

Rescue Ladder

The Rollgliss™ Rescue Ladder provides a way to assist rescue after a fall has occurred. It can be anchored to a structure and dropped down to the victim's level, so they can climb either up or down to safety. The ladder can be used by any able-bodied victim not incapacitated by the fall.

- Available in 8' (2.4 m) sections.
- Extra sections can be added together for longer length.
- Includes three carabiners for attachment.

Part #	Description
8516294	Rollgliss™ Rescue Ladder



Rollgliss™ Rescue Ladder Anchor

Accessory plate for mounting rescue ladder to a davit arm or single anchorage point.

Part #	Description
8516316	Rollgliss™ Rescue Ladder Anchor

Rescue and Descent

3M™ DBI-SALA® Rollgliss™

Technical Rescue Line

Find everything you need for rigging—from single descent systems to flying foxes—in our Rollgliss™ Technical Rescue line. It complements our already-established line of industrial rescue systems, including pre-rigged rescue kits like the Rollgliss™ R350 and others.

Descenders

Part #	Description
8700388	Double Stop Descender Range: Anodized gold/blue aluminum, suits 12.5 mm - 13.0 mm rope
8700387	Double Stop Descender Range: Anodized gold aluminum, suits 10.5 mm - 12 mm rope
2103189	Fisk Descender



Fisk Descender

- Gentle flow for 19" (48.3 cm) of lifeline to pass through the descender.
- Large radius for smoother descent and less wear to lifeline.
- Reduction in rope hockling and torsional twist.
- Durable 304 stainless steel construction.



2103189

3M™ DBI-SALA® Rollgliss™

Accessories

Part #	Description
1234081	Adjustable Rope Positioning Lanyard : Steel carabiner on one end and rope adjuster with steel carabiner at the other end x 8' (2.4 m).
1234080	Aluminum carabiner on one end and rope adjuster with aluminum carabiner at the other end x 8' (2.4 m)



1234081

3M™ DBI-SALA®

Ascender

Part #	Description
8700522	Retrofit Chest Ascender: Anodized gold aluminum, retrofit with rope size of 7/16" - 1/2" (10.5 mm - 13 mm)



3M™ DBI-SALA®

Carabiners and Quick Links

Carabiners



2000117



2000114



2000025

Quick Links



9509238



	Part #	Description	Material	Gate opening	Locking mechanism	Minimum breaking strength
ANSI	2000117	Medium offset D fall arrest carabiner, captive eye, ANSI rated	Steel	3/4" (19 mm)	Autolock, double action	5,000 lb (22 kN)
	2000114	Extra large parabiner fall arrest carabiner, captive eye, ANSI rated	Steel	2.13" (54 mm)	Autolock, double action	7,875 lb (35 kN)
	2000025	Medium parabiner fall arrest carabiner, ANSI rated	Alum	3/4" (19 mm)	Autolock, triple action	5,000 lb (22 kN)
Quick Links	9509238	Delta style quick link	Steel	1/4" (7 mm)	Manual closing screw	10,125 lb (45 kN)



Fall Protection

Stand with us

to help reduce suspension trauma.

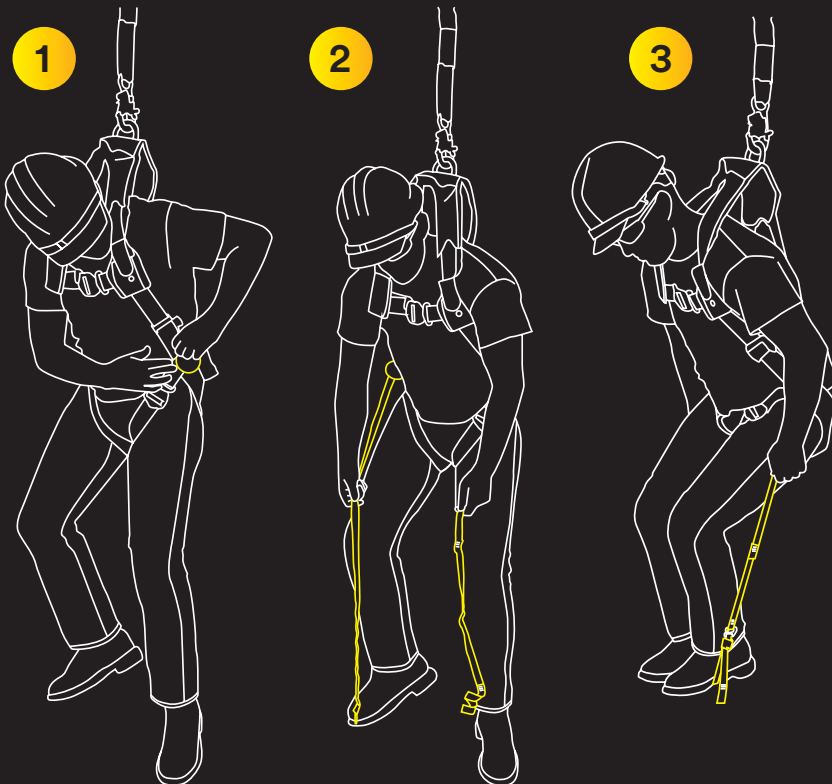

Suspension Trauma Safety straps can help prevent suspension trauma.



Leg Circulation

Helps relieve pressure applied to arteries and veins around the top of legs after fall.



Heart Circulation

Helps reduce anxiety and the onset of shock which prevents an increased heart rate.



Brain Circulation

Recirculates blood flow to the brain, helping reduce the chance of going into cardiac arrest, having brain damage, or death.

Join us at [3M.ca/FallProtection](https://www.3m.ca/FallProtection).



Fall Protection
for Tools

Fall Protection for Tools



Aiming for a zero-drop policy.

Protecting workers takes more than just keeping them from falling. From construction sites to oil rigs, 3M™ DBI-SALA® Fall Protection for Tools makes work environments safer and more productive by drastically reducing falling object incidents that can result in personal injury, equipment damage, and tool loss.

Certified and tested.

Our drop prevention solutions are designed with the craft in mind, and are third-party tested in the harshest possible conditions – extreme heat, cold, moisture, corrosion and abrasion. We conduct dynamic and static strength tests, both in the field and in our ISO 9001-certified manufacturing facilities to ensure you get high quality and reliable fall protection for tools.

Watch 3M™ DBI-SALA® Fall Protection for Tools in action: <http://bit.ly/FPFTVideos>.

Fall Protection for Tools

Attachment Points

3M™ DBI-SALA®

D-rings

- D-rings can be attached to virtually any tool under 5 lb (2.3 kg) or 2 lb (0.9 kg) using our Quick-Wrap Tape.
- Creates an attachment point in less than a minute.
- Dual D-rings allow for 100% tool tie-off during tool transfers.



Part #	Description	Load rating	Quantity	Non-conductive
1500003*	D-ring 0.5" x 2.25" (1.3 cm x 5.7 cm)	2 lb (0.9 kg)	10 Pack	No
1500004*	D-ring 0.5" x 2.25" (1.3 cm x 5.7 cm)	2 lb (0.9 kg)	100 Pack	No
1500005*	D-ring 0.5" x 2.25" (1.3 cm x 5.7 cm) non-conductive	2 lb (0.9 kg)	10 Pack	Yes
1500006*	D-ring 0.5" x 2.25" (1.3 cm x 5.7 cm) non-conductive	2 lb (0.9 kg)	100 Pack	No
1500007*	D-ring 1" x 3.5" (2.5 cm x 8.9 cm)	5 lb (2.3 kg)	10 Pack	No
1500008*	D-ring 1" x 3.5" (2.5 cm x 8.9 cm)	5 lb (2.3 kg)	50 Pack	No
1500001*	Dual D-ring small	2 lb (0.9 kg)	10 Pack	No

* Indicates that the product is on a certificate or in process of getting placed on one for the ANSI/ISEA 121-2018 standard.



3M™ DBI-SALA® Quick-Wrap Tape

- Heavy duty 1" (2.5 cm) wide tape conforms to the shape of whatever it is applied to.
- Used with our D-rings (see page 118) and Tool Cinch Attachments to create instant tethering points on virtually any tool.
- Made from a self-fusing silicone rubber that leaves no adhesive or residue behind.
- Inner fibreglass webbing increases the strength of the tape and makes the tape resistant to sharp objects.

Part #	Description	Quantity	Length
1500174	Quick wrap, yellow	1 pack	108" (274.3 cm)
1500175	Quick wrap, yellow	10 pack	108" (274.3 cm)
1500168	Quick wrap, blue	1 pack	108" (274.3 cm)
1500169	Quick wrap, blue	10 pack	108" (274.3 cm)
1500171	Quick wrap, blue, 2x length	1 pack	216" (548.6 cm)
1500172	Quick wrap, blue, 2x length	10 pack	216" (548.6 cm)

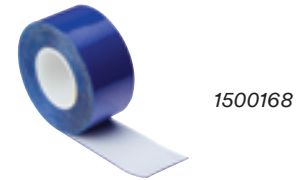

1500168

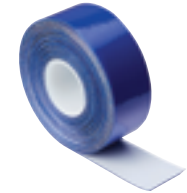

1500171



1500174

3M™ DBI-SALA® Tool Cinch Attachments

- Tool Cinch Attachments feature a cinch design that allows users to quickly secure equipment up to 35 lb (15.9 kg) or 80 lb (36.3 kg).
- Stabilization wings can be used to keep Tool Cinch Attachments in place using our Quick-Wrap Tape.

Part #	Description	Load rating	Quantity	Stabilization wings
1500015*	V-Ring attachment point, stabilization wing	35 lb (15.9 kg)	1 Pack	2
1500016*	V-Ring attachment point, stabilization wing	35 lb (15.9 kg)	10 Pack	2
1500013*	V-Ring attachment point, stabilization wing	35 lb (15.9 kg)	1 Pack	1
1500014*	V-Ring attachment point, stabilization wing	35 lb (15.9 kg)	10 Pack	1
1500011*	V-Ring attachment point, stabilization wing	35 lb (15.9 kg)	1 Pack	None
1500012*	V-Ring attachment point, stabilization wing	35 lb (15.9 kg)	10 Pack	None
1500017*	V-Ring attachment point, stabilization wing	80 lb (36.3 kg)	1 Pack	2
1500018*	V-Ring attachment point, stabilization wing	80 lb (36.3 kg)	10 Pack	2

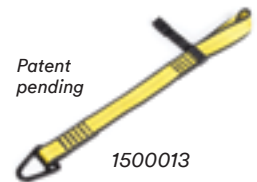

Patent pending

1500013

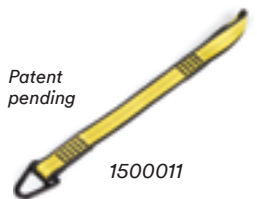

Patent pending

1500011

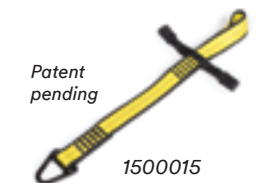

Patent pending

1500015

* Indicates that the product is on a certificate or in process of getting placed on one for the ANSI/ISEA 121-2018 standard.



1500174

1500013



1500174

1500015



1500017



Patent pending

1500017

Fall Protection for Tools

3M™ DBI-SALA® Heat Shrink

- Protect your investment and connection point!
Heat Shrink protects our Quick-Wrap Tape (see *page 119*) from abrasives and harsh work environments.
- Heat Shrink links reduce in size by 200% when heat is applied.

Part #	Description	Quantity
1500019	Heat Shrink 0.75" x 1.75" (1.9 cm x 4.5 cm)	25
1500020	Heat Shrink 1" x 1.75" (2.5 cm x 4.5 cm)	25
1500021	Heat Shrink 1.5" x 2" (3.8 cm x 5.1 cm)	25
1500022	Heat Shrink 2" x 4" (5.1 cm x 10.2 cm)	10
1500023	Heat Shrink 3" x 4" (7.6 cm x 10.2 cm)	10



D-Ring Cord

1500009*

- Easily cinches to tools weighing up to 5 lb (2.3 kg).
- Simply pass the loop end of a D-Ring Cord through a pre-drilled hole or closed handle to create an attachment point.
- Extremely durable and reusable.
- Comes in a pack of 10.

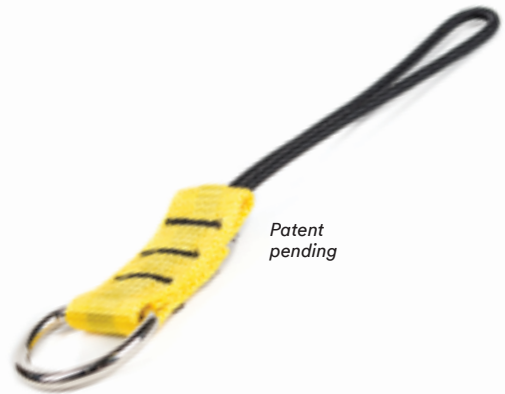

* Indicates that the product is on a certificate or in process of getting placed on one for the ANSI/ISEA 121-2018 standard.

3M™ DBI-SALA® Quick Spins

- Simply slides onto the handle of a tool in seconds.
- Swivel spin top makes them tangle-resistant.
- Reusable and suitable for non-conductive use.
- Comes in packs of 10.



Part #	Description	Quantity
1500027	Small 0.6" (1.5 cm)	10
1500028	Medium 0.8" (2 cm)	10
1500029	Large 1" (2.5 cm)	10
1500030	X-Large 1.2" (3.1 cm)	10
1500031	Pen Holder 0.3" (0.8 cm)	10
1500032	Pen Holder with Coil 0.3" (0.8 cm)	10
1500033	Permanent Marker 0.5" (1.3 cm)	10
1500034	Permanent Marker with Coil 0.5" (1.3 cm)	10

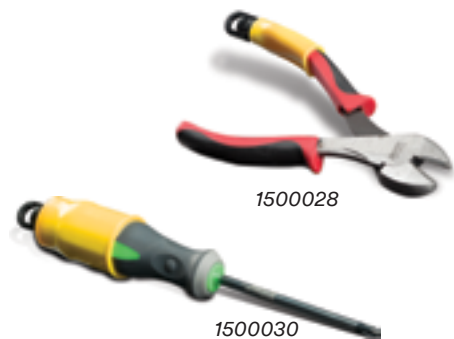

Micro D-Ring

1500010

- Designed to allow for easy tethering of small devices such as cell phones, cameras and radios.
- Adheres to most surfaces creating an attachment point in seconds.
- Load rated for 2 lb (0.9 kg) when used with 1500060 (see page 123).
- Uses 3M very high bond adhesive.
- Comes in packs of 10.



Quick Rings

- Quick Rings are an economical solution for tethering tools quickly.
- Allow many tools up to 2 lb (0.9 kg) to be made tether-ready.
- Ring pliers can be used to simplify quick ring installation.
- Comes in packs of 25.



Part #	Description	Load rating
1500024	Quick Ring, Small 0.75" (1.9 cm)	2 lb (0.9 kg)
1500025	Quick Ring, Medium 1" (2.5 cm)	2 lb (0.9 kg)
1500026	Quick Ring, Large 1.5" (3.8 cm)	2 lb (0.9 kg)



Fall Protection for Tools

Tool Lanyards

3M™ DBI-SALA®

Bungee Tethers



1500047



1500049

Part #	Description	Load rating	Length (relaxed)	Length (stretched)
1500047*	Hook2Loop Bungee Tether	15 lb (4.5 kg)	32" (81.3 cm)	52" (132 cm)
1500048*	Hook2Loop Bungee Tether (10 pack)	15 lb (4.5 kg)	32" (81.3 cm)	52" (132 cm)
1500049*	Medium-Duty Hook2Loop Bungee Tether	35 lb (15.9 kg)	31" (78.7 cm)	52" (132 cm)

* Indicates that the product is on a certificate or in process of getting placed on one for the ANSI/ISEA 121-2018 standard.

Engineered to last.

Built to be more durable and longer-lasting than the competition, our bungee tethers are third-party load rated and thoughtfully designed to prevent dropped objects.



Self-Locking carabiner
The Hook2Loop Bungee Tether features a self-locking carabiner that prevents unintentional openings.



Competitor non-locking carabiners
Non-locking carabiners can be disconnected with a simple twist, potentially resulting in an accidental drop.

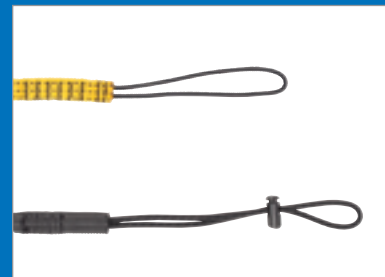

Competitor barrel locks
Many competitive bungee-tether bottoms often utilize a barrel lock. These barrel locks can pose risks as they allow for improper tethering of tools.

3M™ DBI-SALA®

Coil Tethers

An industry-first innovation.

Easy to clean and out of the way—exactly what a tether should be. The lightweight vinyl construction and ultra-compact design of our Coil Tethers makes them an ideal alternative to classic bungee tethers. Since we first introduced them to the marketplace, we've continued to refine and improve our line of coil lanyards with feedback from actual workers in the field.

1500159*

Hook2Hook Coil Tether with Swivel

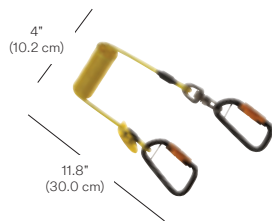

1500067

Trigger2Trigger Coil Tether

- Ideal for use from Wristband.

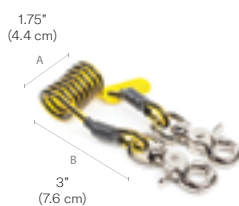

1500059

Clip2Clip Coil Tether

- Non-conductive
- Ideal for use from Wristband.

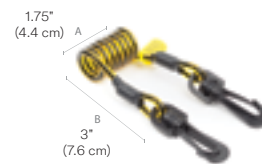

1500065*

Hook2QuickRing Coil Tether with Tail

- Use with hammers and other long-handled tools.
- Available as a combo with our Hammer Holster (see page 129).

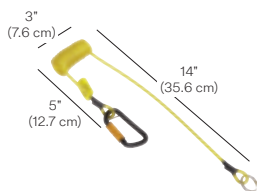

1500060*

Clip2Loop Coil Tether

- Secure cameras, cell phones, radios and other small objects.
- Works well with our Micro D-ring (see page 121).

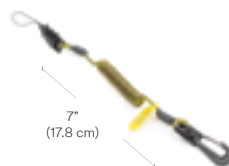

1500178*

Hard Hat Tether

- Simple installation and removal.
- Patented clip holds stronger when force is applied to it.



Part #	Description	Quantity	Load rating	Length (relaxed)	Length (stretched)
1500159	Hook2Hook Coil Tether with Swivel	1	5 lb (2.3 kg)	4" (10.2 cm)	62" (157.5 cm)
1500160	Hook2Hook Coil Tether with Swivel	10	5 lb (2.3 kg)	4" (10.2 cm)	62" (157.5 cm)
1500067	Trigger2Trigger Coil Tether	1	5 lb (2.3 kg)	1.75" (4.4 cm)	24" (70 cm)
1500068	Trigger2Trigger Coil Tether	10	5 lb (2.3 kg)	1.75" (4.4 cm)	24" (70 cm)
1500059*	Clip2Clip Coil Tether	10	2 lb (0.9 kg)	1.75" (4.4 cm)	24" (70 cm)
1500065*	Hook2Quick Ring Coil Tether with Tail	1	2 lb (0.9 kg)	3" (7.6 cm)	62" (157.5 cm)
1500066*	Hook2Quick Ring Coil Tether	10	2 lb (0.9 kg)	3" (7.6 cm)	62" (157.5 cm)
1500060*	Clip2Loop Coil Tether	10	2 lb (0.9 kg)	7" (17.8 cm)	34" (86.4 cm)
1500178*	Hard Hat Tether	10	4 lb (1.8 kg)	4" (10.2 cm)	34" (86.4 cm)
1500179*	Hard Hat Tether	100	4 lb (1.8 kg)	4" (10.2 cm)	34" (86.4 cm)

* Indicates that the product is on a certificate or in process of getting placed on one for the ANSI/ISEA 121-2018 standard.

Fall Protection for Tools

3M™ DBI-SALA®

Retractor

1500069



- Compatible with a number of our Tool Holsters, Wristbands and Tool Pouches.
- Inner 132 cm (52") steel coil allows automatic retraction when not in use.
- 0.7 kg (1.5 lb) load rating.

5 lb Tool Retractor

1500156



- Secure tools up to 5 lb
- Minimize tangling and tripping hazards.
- Reduce line twisting.

Harness Adapter

1500161*



- Designed to be used with new 5 lb. tool retractor
- Can be used on products with black and gold carabiner

Trigger2Trigger Lanyards

- Thumb-controlled trigger snaps on both sides of these lanyards are easy to operate, even while wearing gloves.
- Trigger snaps swivel, making them tangle-resistant.

Top to bottom:
1500057, 1500055,
1500053



Part #	Quantity	Load rating	Length
1500053	1	10 lb (4.5 kg)	12" (30.5 cm)
1500054	10	10 lb (4.5 kg)	12" (30.5 cm)
1500055	1	10 lb (4.5 kg)	24" (60.9 cm)
1500056	10	10 lb (4.5 kg)	24" (60.9 cm)
1500057	1	10 lb (4.5 kg)	36" (91.4 cm)
1500058	10	10 lb (4.5 kg)	36" (91.4 cm)

Medium-Duty Hook2Loop Lanyard

1500050*

- Features an aluminum double-action twist-lock carabiner to prevent accidental opens.
- Works well with medium-duty tool cinch (see page 119).



Part #	Load rating	Length
1500050*	35 lb (15.9 kg)	72" (182.9 cm)

* Indicates that the product is on a certificate or in process of getting placed on one for the ANSI/ISEA 121-2018 standard.

3M™ DBI-SALA®

Heavy-Duty Hook2Loop Lanyard

1500051*

- Features an aluminum double-action twist-lock carabiner to prevent accidental opens.
- Works well with heavy-duty tool cinch (see page 119).

Part #	Load rating	Length
1500051*	80 lb (36.3 kg)	72" (182.9 cm)



Heavy-Duty Hook2Rail Lanyard

1500052*

- Features an aluminum double-action twist-lock carabiner to prevent accidental opens.
- Large double-action twist-lock rail carabiner.
- Works well with heavy-duty tool cinch (see page 119).

Part #	Load rating	Length
1500052*	80 lb (36.3 kg)	81" (206 cm)



* Indicates that the product is on a certificate or in process of getting placed on one for the ANSI/ISEA 121-2018 standard.

Fall Protection for Tools

Tool Holsters

3M™ DBI-SALA®

Smart Holsters

Your tools, at the ready.

Safer. Easier. It's not often that your job can be both, but 3M™ DBI-SALA® Smart Holsters are engineered for exactly that. These next generation tool pouches feature intelligent productivity features that are designed to keep your tool right where you want it at all times.

High-visibility reflectors

Products equipped with our high-visibility reflectors are always easy to identify and locate, even when left in dark spaces. The highly reflective material stitched into the front and back of the holster makes it easily detectable with a flashlight even in low-light conditions.



The faster, smarter way to holster

Our technology speeds up your workflow and reduces how often your tools need to be holstered. This powerful magnetic tool staging system allows tools to simply stick to the holster, ensuring the tool you need is always at the ready.



Bottom drain vent

You're at your best when your tools are too. The integrated drain vent in our Smart Holsters protects your tools from rusting and your holster from dry rot. Even in rainy weather conditions, the drain vent helps keep the holster dry by allowing water to pass through at all times.



3M™ DBI-SALA®

Single and Dual Tool Holsters

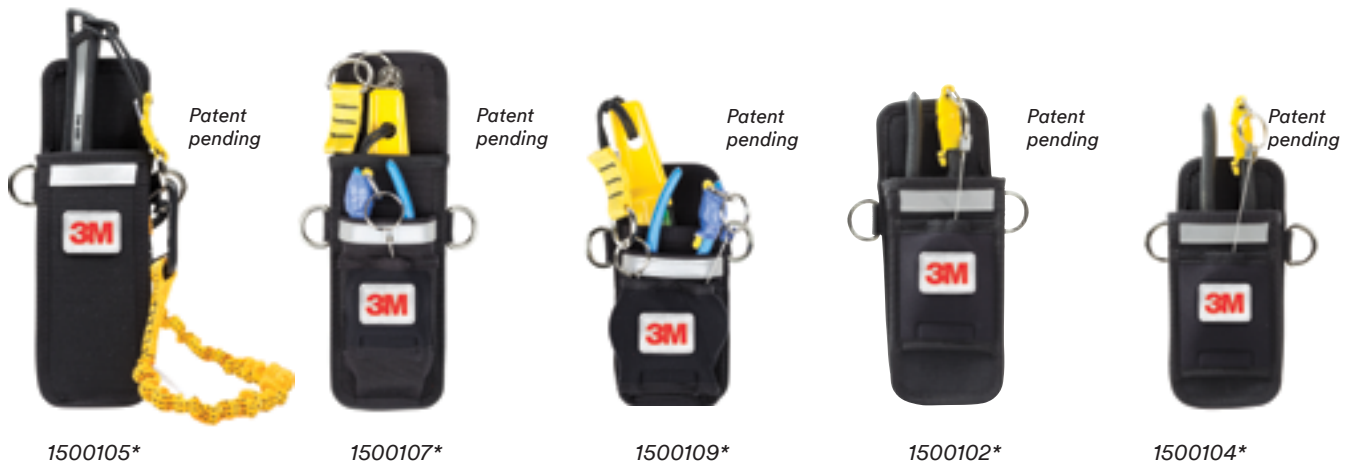

[1] Hook2Loop Bungee Tether sold separately.

- Single and Dual Tool Holsters are equipped with D-rings that are load rated for 5 lb (2.3 kg).
- Several variants of these holsters come with Retractors (indicated below) (see page 124). Retractors are load rated for 1-1/2 lb (0.7 kg).
- Single and dual tool holsters feature High-Visibility Reflectors and the Magnetic Tool Staging System.
- A bottom drain vent allows the holster to perform even in wet conditions.

Part #	Description	Retractors included	Attachment
1500104*	Single Tool Holster with Retractor	1x	Harness
1500102*	Single Tool Holster with Retractor	1x	Belt
1500105*	Extra-Deep Single Tool Holster	None	Belt
1500108*	Dual Tool Holster	None	Harness
1500109*	Dual Tool Holster with Retractors	2x	Harness
1500106*	Dual Tool Holster	None	Belt
1500107*	Dual Tool Holster with Retractors	2x	Belt

* Indicates that the product is on a certificate or in process of getting placed on one for the ANSI/ISEA 121-2018 standard.

Fall Protection for Tools

3M™ DBI-SALA® Tape Measure Holsters

- Designed to be used with virtually any tape measure, or the optional tape measure sleeve, allowing tape measures to be safely tethered and holstered.
- Includes a Retractor (see page 124).
- The tape measure sleeve conforms to the size of nearly every tape measure.
- Features High-Visibility Reflectors.



Back of holster



1500099 Patent pending

Part #	Description
1500098*	Tape Measure Holster with Retractor
1500099*	Tape Measure Sleeve
1500100*	Tape Measure Holster with Retractor and Sleeve Combo
1500166	Tape Measure Holster Sleeve with Retractor and Large Sleeve Combo

Large Tape Measure Sleeve

1500165*

- Compliment to existing 25' Tape Measure Sleeve.
- Provides a solution for most large tape measures used on a job site.



Pouch Holster with Retractor

1500095*

- Quickly holster tape measures and other small tools.
- Includes a Retractor (see page 124).



Patent pending

Scaffold Wrench Holster with Retractor

- Quickly holster scaffold wrenches while working at height.
- Features High-Visibility Reflectors.

Part #	Description
1500096*	Scaffold Wrench Holster with Retractor
1500097	Scaffold Wrench Holster with Retractor and Hook2Loop Bungee Tether

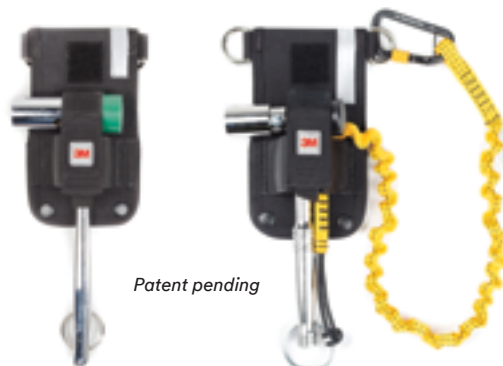

Patent pending



Back of holster features pouch for Safety Retractor (see page 124). Rear feed system allows retractor to tie off a scaffold wrench while staying out of the way.

* Indicates that the product is on a certificate or in process of getting placed on one for the ANSI/ISEA 121-2018 standard.

3M™ DBI-SALA® Hammer Holster

- The Hammer Holster allows for the safe holstering of virtually any hammer under 5 lb (2.3 kg).
- D-ring on the side of the holster is load rated for 5 lb (2.3 kg).
- The 1500094 combo comes with a 1500065 Hook2Quick Ring Coil Tether (see page 123) that is specially designed for use with the Hammer Holster. The Hook2Quick Ring Coil Tether is load rated for 2 lb (0.9 kg).
- During transport, the Hammer Holster can be locked shut with a hook and loop strap. While being used, the strap can be locked up allowing for easy hammer access and holstering.

Part #	Description
1500093*	Hammer Holster
1500094*	Hammer Holster and Hook2Quick Ring Coil Tether



Patent pending

Top: Hammer Holster is locked, preventing hammer from slipping out.

Bottom: Hammer Holster is unlocked, making it suitable for active use.

Adjustable Radio Holster

- Holster adjusts to fit virtually any hand-held radio, cell phone, and many other devices.
- Can be worn from belt or harness.
- A Micro D-Ring (see page 121) can be placed on the back of a device, and can then be tethered to a D-ring on the front of the Adjustable Radio Holster using a 1500065 Clip2Loop Coil Tether (see page 123).

Part #	Description
1500088*	Adjustable Radio Holster
1500089	Adjustable Radio Holster, Clip2Loop Coil Tether and Micro D-Ring



Patent pending

1500088

1500060

Can be worn from a belt or harness.

Spray Can/Bottle Holster

- Flexible neoprene holster allows for quick tethering of bottles and spray cans.
- 1500092 comes with 1500059 Clip2Clip Coil Tether (see page 123).

Part #	Description
1500091*	Spray Can/Bottle Holster
1500092	Spray Can/Bottle Holster and Clip2Clip Coil Tether



* Indicates that the product is on a certificate or in process of getting placed on one for the ANSI/ISEA 121-2018 standard.

Fall Protection for Tools

3M™ DBI-SALA® Battery Holster/Sleeve

1500090*

- Unique sleeve design conforms to the size of virtually any drill battery.
- Sleeve is cinched to the drill, allowing the drill to be tethered off while being used at height.
- 10 lb. (4.5 kg) load rating.



Comfort Tool Belt

- Extra padding provides superior comfort compared to many other tool belts.
- Modular approach allows user to customize their own holster and pouch system.



Part #	Waist size	Size
1500110*	28" - 36" (71 cm - 91 cm)	S-M
1500111*	36" - 44" (91 cm - 112 cm)	L-XL
1500112*	44" - 52" (112 cm - 132 cm)	2X-3X

Utility Tool Belt

- Padded cordura provides for durability and comfort.

Part #	Waist size	Size
1500113	28" - 46" (71 cm - 117 cm)	S-L
1500114	40" - 54" (102 cm - 137 cm)	XL-3X



Belt Loops

- 1500115* is used for tying off tools from a belt, while the 1500118 is used for staging tools.

Part #	Description	Load rating	Quantity
1500115*	Belt loop D-ring	5 lb (3.2 kg)	1
1500116*	Belt loop D-ring	5 lb (3.2 kg)	10
1500118	Belt loop trigger	5 lb (3.2 kg)	10



* Indicates that the product is on a certificate or in process of getting placed on one for the ANSI/ISEA 121-2018 standard.

3M™ DBI-SALA® Small Parts Pouches

- Innovative self-closure system traps objects inside, making it nearly impossible for objects to fall out once placed in the bag.
- Easy to retrieve objects since no opening or closing is necessary.
- Compatible with most tool belts.



Belt loops located on back of pouch.

Part #	Description
1500123*	Small Parts Pouch, extra deep canvas black
1500121*	Small Parts Pouch, canvas orange
1500120*	Small Parts Pouch, canvas camo
1500122*	Small Parts Pouch, vinyl yellow
1500119*	Small Parts Pouch, canvas black

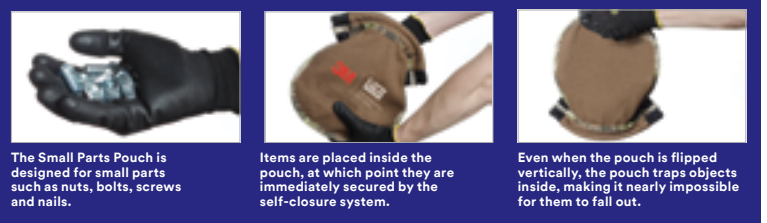

The Small Parts Pouch is designed for small parts such as nuts, bolts, screws and nails.

Items are placed inside the pouch, at which point they are immediately secured by the self-closure system.

Even when the pouch is flipped vertically, the pouch traps objects inside, making it nearly impossible for them to fall out.

3M™ DBI-SALA® Utility Pouch

- Features two outside pockets for storing spud wrenches and two inner pockets for storing additional tools.
- Tools can be tethered to D-rings on the inside and outside of the pouch.
- Adjustable side-release closure system helps prevent objects from falling out when the pouch isn't being used.

Part #	Product variant
1500132	Utility pouch
1500130*	Utility pouch with zipper closure



Inspection Pouch

1500131*

- Designed for the safe transport and use of most multi-meters, air monitors, and other portable testing devices.
- A unique patent pending adjustable opening can be used to create a hands-free workstation off the hip or chest.
- Can be worn off a belt, or over the shoulder using the included shoulder strap.



Hands-free workstation from belt or shoulder.

Patent pending

* Indicates that the product is on a certificate or in process of getting placed on one for the ANSI/ISEA 121-2018 standard.

Fall Protection for Tools

Tool Pouches

- Constructed from a heavy-duty canvas with an inner lining to help prevent punctures.
- Multiple inner pockets accommodate a number of tools while an integrated D-ring makes tethering tools incredibly easy.
- Available in standard and extra-deep variations.
- The standard pouch uses a hook and loop closure system that can be locked open during use.
- The extra-deep Tool Pouch features a magnetic closure system as well as a side-release buckle.

Part #	Width	Height	Retractors/triggers
1500124	7.5" (19.1 cm)	11" (27.9 cm)	-
1500125	7.5" (19.1 cm)	11" (27.9 cm)	2 retractors
1500126	7.5" (19.1 cm)	11" (27.9 cm)	2 triggers
1500127	8.75" (22.2 cm)	13" (33 cm)	-
1500128	8.75" (22.2 cm)	13" (33 cm)	2 reactors



Spill Control Buckets

3M™ DBI-SALA®

Safe Buckets

With an integrated closure system that helps prevent dropped objects, our Safe Buckets are designed to be the perfect companion for workers at height carrying heavy loads.

Closure systems

Every Safe Bucket features either a unique, patent-pending drawstring or a locking hook and loop closure system that acts as an extra layer of spill-protection during transport and lifting. Colourful indicator tabs provide quick visual cues to indicate whether the bucket is in lockdown mode or easy-access mode.



Built-in connection points

The Safe Bucket was engineered for use with tools at height, and includes multiple connection points for tethering.

High-quality canvas and vinyl

Safe Buckets are available in both heavy-duty canvas and vinyl variants that are load rated for 100 lb (45.4 kg) and 250 lb (113.4 kg) respectively.



1500134



1500140

3M™ DBI-SALA®

Standard Safe Bucket Models

Integrated carabiner and hoisting strap

Instead of rope, which is susceptible to fraying, a heavy-duty hoisting/shoulder strap is built into every Safe Bucket. Each bucket is also equipped with a high-quality and lightweight aluminum twist-lock carabiner load rated for 30 kN (6,700 lb). There is no need to worry about a knot failing, or a non-locking carabiner which may slip off at a connection point.



Puncture resistance

Where you work, durability is non-negotiable. That's why every Safe Bucket features hard composite plating at the bottom to protect it from accidental punctures. A leather sleeve also covers the inserts, protecting them from the elements and harsh work environments.

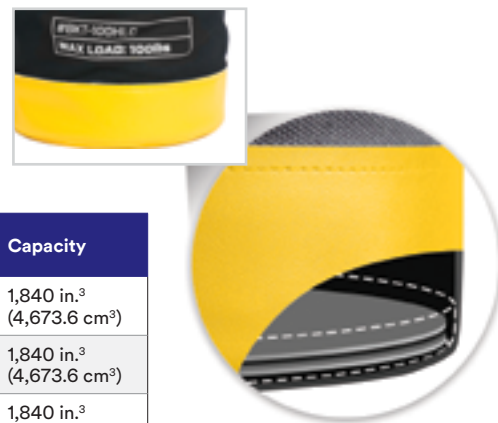

Part #	Load rating	Closure system	Body material	Height/diameter	Capacity
1500134	100 lb (45.4 kg)	Hook and loop	Canvas	15"/12.5" (38 cm/31.75 cm)	1,840 in. ³ (4,673.6 cm ³)
1500133	100 lb (45.4 kg)	Drawstring	Canvas	15"/12.5" (38 cm/31.75 cm)	1,840 in. ³ (4,673.6 cm ³)
1500140	250 lb (113.4 kg)	Hook and loop	Vinyl	15"/12.5" (38 cm/31.75 cm)	1,840 in. ³ (4,673.6 cm ³)
1500139	250 lb (113.4 kg)	Drawstring	Vinyl	15"/12.5" (38 cm/31.75 cm)	1,840 in. ³ (4,673.6 cm ³)

3M™ DBI-SALA®

Hard-Body Safe Bucket Insert

1500141

- Converts a standard soft-body Safe Bucket into a hard-body Safe Bucket.
- Our reusable hard-body Safe Bucket insert keeps your Safe Bucket standing upright, making it easier to stage tools and stay productive.
- Integrated inner pockets allow tools to be holstered and organized quickly.



Fall Protection for Tools

5 Gallon Safe Bucket

1500135

- Used to transport standard 5 gallon (18.9 L) buckets.
- 5 gallon (18.9 L) plastic buckets clip into the Safe Bucket with a unique hook system.
- When not being used, the Safe Bucket can be flattened for easy storage.
- Unique patent pending locking hook and loop closure system helps ensure that there are no accidental spills during lifting and transportation.
- 100 lb. (45.5 kg) load rating.



Plastic bucket not included.

3M™ DBI-SALA® Long Safe Buckets

- Transport scaffolding and longer tools safely and easily with our Long Safe Buckets.
- More effective than hand-to-hand transportation or using rope with hitch knots.
- Hook and loop top closure system helps keep poles secure during lift.
- Equipped with a double twist-action locking carabiner for maximum safety.

Part #	Length	Closure system	Load rating
1500136	48" (122 cm)	Hook and loop	100 lb (45.4 kg)
1500137	72" (183 cm)	Hook and loop	100 lb (45.4 kg)
1500138	120" (305 cm)	Hook and loop	100 lb (45.4 kg)

1500136



3M™ DBI-SALA® Pullaway Wristbands

Pullaway wristbands are designed for those who work around rotating or moving equipment. They feature an elastic strap to conform to the wearer's wrist size automatically and come in standard and slim variants.

Part #	Description	Qty.	Load rating
1500071*	Pullaway Wristband, small	10	5 lb (2.3 kg)
1500073*	Pullaway Wristband, medium	10	5 lb (2.3 kg)
1500074*	Pullaway Wristband, large	1	5 lb (2.3 kg)
1500075*	Pullaway Wristband, large	10	5 lb (2.3 kg)
1500077*	Pullaway Wristband, small (slim)	10	5 lb (2.3 kg)
1500079*	Pullaway Wristband, medium (slim)	10	5 lb (2.3 kg)
1500080*	Pullaway Wristband, large (slim)	1	5 lb (2.3 kg)
1500081*	Pullaway Wristband, large (slim)	10	5 lb (2.3 kg)



Pullaway Wristband



Slim Pullaway Wristband



Adjustable Wristbands



Adjustable Wristband

Our adjustable wristband uses a hook and loop system to adjust to any wrist size. An elastic band helps ensure a comfortable fit.



Adjustable Wristband with Cord

Adjusts to any wrist size using a hook and loop system. A built-in cord is used to quickly attach and stage tools directly to the wristband.



Adjustable Wristband with Retractor

Adjusts to any wrist size. A built-in retractor with an attached trigger can be used to quickly work with many hand tools.

Part #	Description	Qty.	Load rating
1500082*	Adjustable Wristband	1	5 lb (2.3 kg)
1500083*	Adjustable Wristband	10	-
1500084*	Adjustable Wristband with Cord	1	5 lb (2.3 kg)
1500085*	Adjustable Wristband with Cord	10	-
1500086	Adjustable Wristband with Retractor	1	1.5 lb (0.7 kg)
1500087	Adjustable Wristband with Retractor	10	-

* Indicates that the product is on a certificate or in process of getting placed on one for the ANSI/ISEA 121-2018 standard.



Fall Protection
for Tools

Common Tool Attachment Points

Tools up to 0.5 kg (1 lb.)

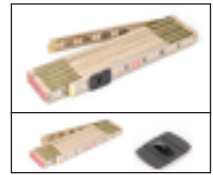

Tools up to 0.9 kg (2 lb.)

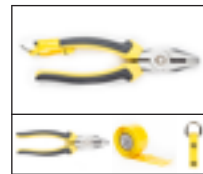

Tools up to 2.3 kg (5 lb.)

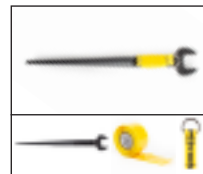
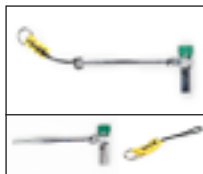
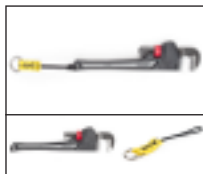

Tools up to 15.9 kg (35 lb.)

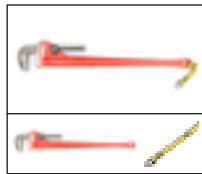
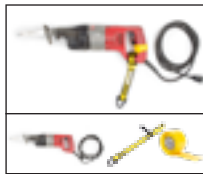
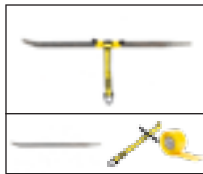

Tools up to 36.3 kg (80 lb.)

Protect with Heat Shrink

Heat Shrink can be used to protect Quick Wrap Tape from dust, abrasives, and harsh work environments. Apply Heat Shrink over Attachment Points that use Quick Wrap tape to make them last longer.



Apply a Heat Shrink Link over an attachment point that uses Quick Wrap Tape. Apply heat using a heat gun until the link shrinks completely. Do not burn the Heat Shrink Link.

Let the Heat Shrink Link cool for 5 minutes before use. Remember to always inspect the connection prior to each use for damage or irregularities that might affect the connection.

Attachment Point Legend



Micro D-Ring
1500010
0.9 kg (2 lb.) load rating only when used with 1500060



Quick Spin
1500027, 1500028, 1500029, 1500030
Load Rating: 0.5 kg (1 lb.)



Quick Ring
1500024, 1500025, 1500026
Load Rating: 0.9 kg (2 lb.)



D-Ring 12.7 mm x 57.15 mm (0.5" x 2.25")
1500003
Load Rating: 0.9 kg (2 lb.)



D-Ring 25.4 mm x 88.9 mm (1" x 3.5")
1500007
Load Rating: 2.7 kg (5 lb.)



Quick Wrap Tape 25.4 mm (1") Wide
1500168, 1500171, 1500174



D-Ring Cord
1500009
Load Rating: 2.7 kg (5 lb.)



Tool Cinch MD
1500011
Load Rating: 15.9 kg (35 lb.)



Tool Cinch MD Single Wing
1500013
Load Rating: 15.9 kg (35 lb.)



Tool Cinch MD Dual Wing
1500015
Load Rating: 15.9 kg (35 lb.)



Tool Cinch Heavy Duty
1500017
Load Rating: 36.3 kg (80 lb.)



Hard Hat Tether
1500178
Load Rating: 0.9 kg (2 lb.)

3M™ DBI-SALA® Engineered Systems

3400932C

3M™ DBI-SALA® Sealed-Blok Self Retracting Lifeline

Includes an RSQ dual-mode design allowing you to choose between fall arrest mode or descent mode, depending on your needs.

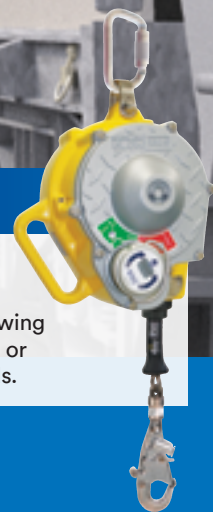

Flexibility for demanding worksites.

Meet the fall protection needs of your unique worksite with a safety system designed specifically for your application. A 3M certified specialist will help you with options for the selection, installation, training and use of your engineered system. Contact customer service to find a certified specialist to assist you.

Overhead Applications

- Specifically designed to meet the needs of transport and industrial applications.
- Can be used for work at height on trains, trucks, aircraft, crane walkways and loading bays.
- Supports self-retracting lifelines and controlled rate descent devices up to 33.1 lb.
- Allows up to 200' single span for one user and up to 100' single span for multiple users.*

Contact EngineeredSystems-FP@mmm.com to find a certified specialist today.

**The number of system users and span lengths must be verified by the calculation software.*

3M™ DBI-SALA® Engineered Systems



3500221

3M™ DBI-SALA® Nano-Lok™ edge Quick-Connect Self-Retracting Lifeline

8' (2.4 m) lifeline with 3/16" (5 mm) galvanized steel wire rope and aluminum captive carabiner, quick connector for harness mounting.

Wall and Floor Applications

- Engineered lifeline systems can be used for modern building projects, refurbishments and industrial safety applications.
- Can be fitted to steel beams, concrete and brickwork.
- Suitable for use on older roof constructions in conjunction with fabricated anchor posts.*

**Not supplied by 3M Fall Protection.*

Contact **EngineeredSystems-FP@mmm.com** to find a certified specialist today.

Notes:

⚠WARNING

Compliant fall protection and emergency rescue systems help prevent serious injuries associated with fall events. Users must read and understand the User Instructions provided with the product, and must be properly trained by their employers in the safe use of these systems before using them, per CSA standards and provincial legislation. Misuse or failure to follow warnings and instructions may result in serious personal injury or death. For proper use, see supervisor, User Instructions, or call 1-800-387-7484



3M Fall Protection
3M Canada

P.O. Box 5757
London, ON N6A 4T1
1-800-364-3577
3M.ca/FallProtection

Kevlar, Nomex and Technora are trademarks of their respective owners.

Apple, the Apple logo, iPad, and iPhone are trademarks of Apple Inc., registered in the U.S. and other countries.

Android is a trademark of Google LLC.

3M, 3M Science, Applied to Life., Flexiguard, Nano-Lok, DBI-SALA, ExoFit, Delta, Revolver, EZ-Link, STRATA, Duo-Lok, Tech-Lite, SecureFit, Saflok, EZ-Stop, Retrax, Cynch-Lok, Zorbit, Fast-Line, Dyneema, Lad-Saf, EZ-Line, Protecta, Rebel, Mobi-Lok, Salalift, i-Safe, Advanced, Rollgliss, Technora, Uniline, LIFTech and Ultra-Lok are trademarks of 3M. Used under license in Canada. Please recycle. Printed in Canada.
© 2021, 3M. All rights reserved.

All other trademarks referenced are the trademarks of their respective owners. 2103-19897 E